



宁波江北鑫祥音响电子有限公司
Ningbo Xinxiang Audio Electronical Co.,Ltd

地址：宁波余姚市河姆渡镇泾浦庵村
Add: Jingpuan, Hemudu Town, Yuyao, Ningbo, Zhejiang, China

Fax	+0086-574-62966217	Post	315414
Email	Info@xinxiangsound.com sales@xinxiangsound.com	Tel	+8613056995678 +0086-574-87576831

NINGBO XINXIANG AUDIO ELECTRONICAL CO.,LTD
宁波江北鑫祥音响电子有限公司



Ningbo Xinxiang Audio Electronical Co., Ltd. a professional supplier of audio equipments since 2009 in Ningbo. We specialized in developing and manufacturing stands on stage, like stage stands, including mobile stage stands, stage truss, music stand, microphone stand, speaker stand, lighting stand, keyboard stool, TV bracket etc.



We always adhered to "quality of products in order to survive, credibility and development services" business purposes. Committed to providing you with high-quality products and quality services. Have a professional, dedicated design management team, from product design, mold making, molding to the Product assembly, for each aspect and processes are rigorously testing and control.



We are trying our best to meet customers' requirements, providing our top quality products and service. Your satisfaction is always what we pursuit, let's create and enjoy a great cooperation together.

COMPANY PROFILE

Ningbo Xinxiang Audio Electronical Co.,Ltd

CONTENTS

MICROPHONE STAND	1
SPEAKER STAND	12
STUDIO GEAR	20
GUITAR STAND	21
KEYBOARD STAND	27
RACK	36
KEYBOARD STOOL	41
MUSIC STAND	45
LIGHTING STAND	49
MOBILE STAGE STAND	56
LINE ARRAY STAND	61
ALUMINIUM TRUSS	62
HOOK CLAMP	69
TRIPLE WORKSTATION	70
GARDEN CART	71
DJ LAPTOP&MONITOR STAND	72
DJ BOOTH	75
INSTRUMENT BAG	76
MIRROR BALL STAND	77
DANCE FLOOR	78
STAGE SYSTEM	79
MICROPHONE CABLE	80
INSTRUMENT CABLE	82
SPEAKER CABLE	84
SNAKE CABLE	88
CONNECTOR	92

**XA-201**

Height	920-1580mm
Arm Length	750mm
Color	B/W
Inner box	9*9*92cm(1pcs)
Master Carton	30*20*94cm(6pcs)

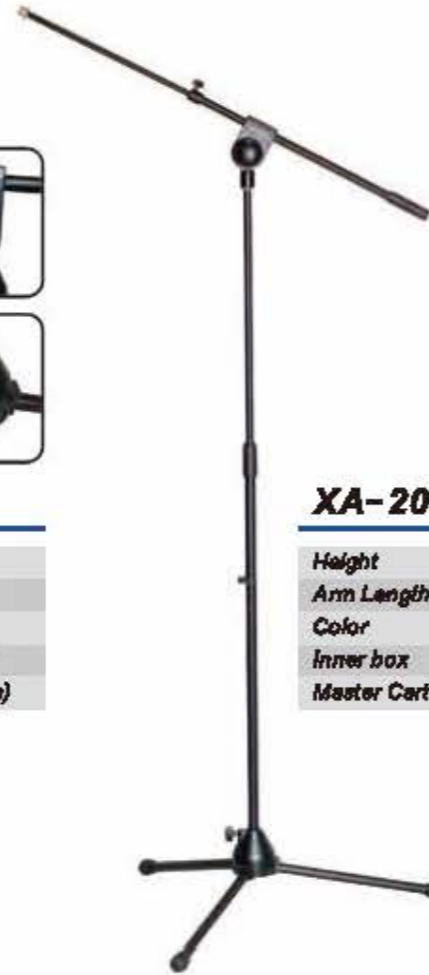
**XA-201T**

Height	920-1580mm
Arm Length	520-780mm
Color	B/W
Inner box	9*9*94cm(1pcs)
Master Carton	30*20*96cm(6pcs)

**XA-202**

Height	920-1580mm
Arm Length	750mm
Color	B/W
Inner box	9*9*92cm(1pcs)
Master Carton	30*20*94cm(6pcs)

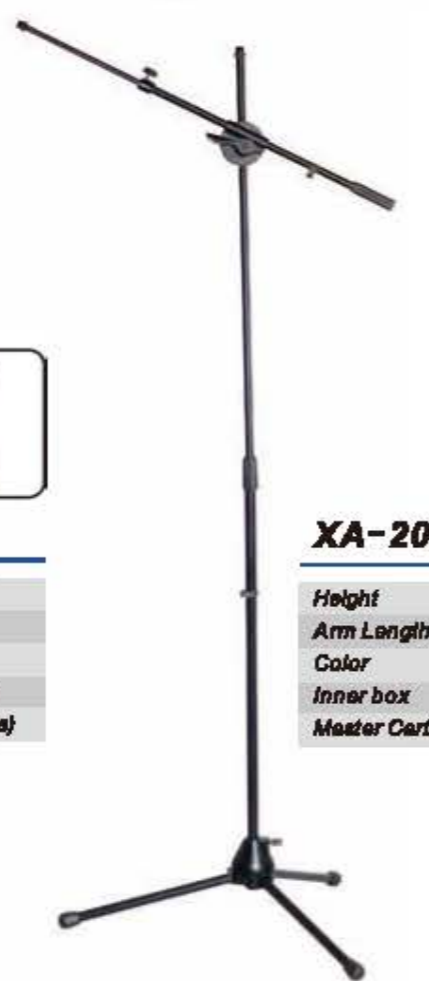
**XA-202T**

Height	920-1580mm
Arm Length	520-780mm
Color	B/W
Inner box	9*9*94cm(1pcs)
Master Carton	30*20*96cm(6pcs)

**XA-203**

Height	920-1580mm
Arm Length	750mm
Color	B/W
Inner box	9*9*90cm(1pcs)
Master Carton	30*20*82cm(6pcs)

**XA-204**

Height	920-1580mm
Arm Length	750mm
Color	B/W
Inner box	9*9*84cm(1pcs)
Master Carton	30*20*86cm(6pcs)

**XA-203T**

Height	920-1580mm
Arm Length	520-780mm
Color	B/W
Inner box	9*9*82cm(1pcs)
Master Carton	30*20*84cm(6pcs)

**XA-204T**

Height	920-1580mm
Arm Length	520-780mm
Color	B/W
Inner box	9*9*86cm(1pcs)
Master Carton	30*20*88cm(6pcs)





XA-205

Height	920-1560mm
Arm Length	750mm
Color	B/W
Inner box	9*9*92cm(1pc)
Master Carton	30*20*94cm(6pcs)



XA-205T

Height	920-1580mm
Arm Length	520-760mm
Color	B/W
Inner box	9*9*95cm(1pc)
Master Carton	30*20*97cm(6pcs)



XA-206

Height	920-1520mm
Arm Length	750mm
Base Diameter	Φ250mm
Color Base	R/YBL/CH
Inner box	Triangle box
Carton	90*38*19cm(4pcs)



XA-206T

Height	920-1520mm
Arm Length	520-760mm
Base Diameter	Φ250mm
Color Base	R/YBL/CH
Inner box	Triangle box
Carton	90*38*19cm(4pcs)



XA-208

Height	920-1520mm
Arm Length	Φ250mm
Color Base	R/YBL/CH
Inner box	Triangle box
Carton	90*38*19cm(4pcs)



XA-209

Height	920-1520mm
Arm Length	Φ250mm
Color Base	R/YBL/CH
Inner box	Triangle box
Carton	90*38*19cm(4pcs)



XA-210

Height	1040-1560mm
Color	R/YBL/CH
Inner box	8*8*92.5cm(1pc)
Master Carton	30*20*95cm(6pcs)



XA-212

Height	380-520mm
Arm Length	520mm
Color	B/W
Inner box	9*9*54mm (1pcs)
Master Carton	30*20*56cm(6pcs)



XA-212T

Height	380-520mm
Arm Length	520-780mm
Color	B/W
Inner box	9*9*57mm (1pcs)
Master Carton	30*20*59cm(6pcs)



XA-213

Height	380-520mm
Arm Length	520mm
Color	B/W
Inner box	9*9*54mm (1pcs)
Master Carton	30*20*56cm(6pcs)



XA-213T

Height	380-520mm
Arm Length	520-780mm
Color	B/W
Inner box	9*9*57mm (1pcs)
Master Carton	30*20*59cm(6pcs)



XA-226S

Height	380-520mm
Arm Length	520mm
Color	R/Y/BL/BK
Inner box	11*11*65mm (1pcs)
Master Carton	66*33*23cm(6pcs)



XA-226ST

Height	380-520mm
Arm Length	580-910mm
Color	R/Y/BL/BK
Inner box	11*11*65mm (1pcs)
Master Carton	66*33*23cm(6pcs)



XA-211

Height	380-520mm
Arm Length	420mm
Base Diameter	Φ160mm
Color Base	R/Y/BL/CH
Inner box	17.5*6.5*48mm (1pcs)
Master Carton	21*19*47cm(8pcs)



XA-227S

Height	380-520mm
Arm Length	800mm
Color	R/Y/BL/BK
Inner box	17.5*65*48mm (1pcs)
Master Carton	21*15*47cm(6pcs)
Diameter	178mm



XA-217

Height	1150-1700mm
Arm Length	530-910mm
Color	R/Y/BL/BK
Inner box	11.5*10*92.5mm (1pc)
Master Carton	35*22*95cm(5pcs)

XA-218

Height	1050-1700mm
Arm Length	520-780mm
Color	R/Y/BL/BK
Inner box	9.5*9.5*92.5mm (1pc)
Master Carton	35*22*95cm(5pcs)

XA-219

Height	1050-1700mm
Arm Length	520-780mm
Color	R/Y/BL/BK
Inner box	9.5*9.5*92.5mm (1pc)
Master Carton	32*22*95cm(5pcs)



XA-227A

Height	900-1600mm
Color	R/Y/BL/BK
Inner box	Triangle box
Carton	90*38*19cm(4pcs)
Diameter	258mm

XA-227

Height	900-1600mm
Arm Length	800mm
Color	R/Y/BL/BK
Inner box	Triangle box
Carton	90*38*19cm(4pcs)
Diameter	258mm



XA-226

Height	900-1600mm
Arm Length	800mm
Color	R/Y/BL/BK
Inner box	11*11*93cm(1pc)
Master Carton	94*33*23cm(5pcs)

XA-226T

Height	900-1600mm
Arm Length	580-910mm
Color	R/Y/BL/BK
Inner box	11*11*93cm(1pc)
Master Carton	94*33*23cm(5pcs)

XP-274

Height	1500-2360mm
Boom Length	1140-1940mm
Folded Height	1400mm
Inner box	133*12*12cm(1pcs)
Master Carton	136*24*48cm(2pcs)



XP-275

Height	1360-2300mm
Boom Length	1180-2210mm
Folded Height	1400mm
Inner box	133*22*12cm(1pcs)
Master Carton	136*24*48cm(2pcs)



XAP-006 Diameter: Φ22mm **XAP-007** Diameter: Φ28mm **XAP-008** **XAP-009** Diameter: Φ22mm **XAP-010** Diameter: Φ30mm



XAP-011 Diameter: Φ28mm **XAP-014** **XAP-015** **XAP-016**



XAP-026 **XAP-027** **XAP-017** **XP-298**



XAP-013 **XAP-012**

XA-214

Height	240-380mm
Base Diameter	Φ160mm
Color	R/Y/BL/BK/CH
Inner box	19*4*26cm(1pcs)
Master Carton	22*22*55cm(10pcs)



XA-215

Height	12.5*254mm
Base Diameter	Φ160mm
Color	R/Y/BL/BK/CH
Inner box	17*4*17cm(1pcs)
Master Carton	33*27*18cm(10pcs)



XA-228

Diameter	128mm
Weight	1KG
Inner box	17*4*17cm(1pcs)
Master Carton	33*27*18cm(10pcs)





XAP-031A

XAP-031B

XAP-032A

XAP-032B



XAP-032



XAP-033A



XAP-033B



XAP-034



XAP-035



XAP-035B

SPEAKER STAND

ningbo xinxiang aud. electrical co.,ltd Produce And Design Your Stage!

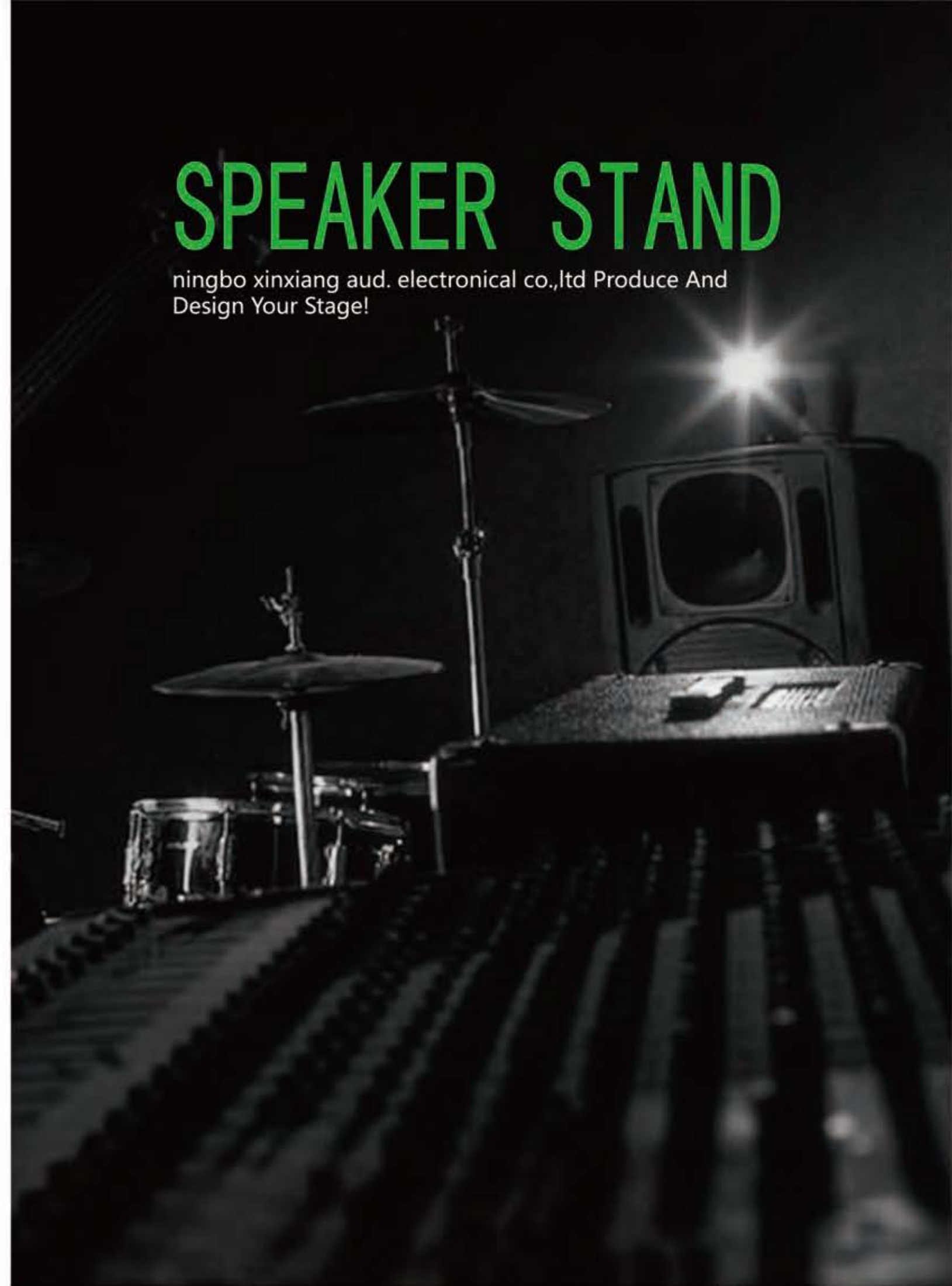





XP-260

Height	1000-1800mm
Load Capacity	50kgs
Inner box	13*11*100cm(1pcs)
Master Carton	103*24*29cm(4pcs)





XP-261

Height	1250-2200mm
Load Capacity	80kgs
Inner box	13.5*11.5*114.5cm(1pcs)
Master Carton	115.2*24*28cm(4pcs)





XP-262

Height	1080-2000mm
Load Capacity	80kgs
Inner box	13.5*11.5*107.5cm(1pcs)
Master Carton	110*24*28cm(4pcs)







XP-263

Height	1080-2000mm
Load Capacity	60kgs
Inner box	13.5*11.5*102cm(1pcs)
Master Carton	110*27*30cm(4pcs)









XP-264

Height	1250-3000mm
Load Capacity	70kgs
Inner box	116*14.5*14.5cm(1pcs)
Master Carton	120*16*30cm(2pcs)









XP-268

Height	1450-2600mm
Load Capacity	75kgs
Inner box	18*15.5*146cm(1pcs)
Master Carton	32*20*149cm(2pcs)



XP-267

Height	1000-1800mm
Load Capacity	35kgs
Inner box	11*9*90cm(1pcs)
Master Carton	39*24*92cm(8pcs)





XP-300

Height	1250-2200mm
Load Capacity	70kgs
Inner box	16*16*136cm(1pcs)
Master Carton	138*18*35cm(2pcs)





XP-280

Height	1250-2200mm
Load Capacity	70kgs
Inner box	25*16.5*119cm(1pcs)
Master Carton	122*27*35cm(2pcs)



XP-282

Height	1100-2100mm
Load Capacity	70kgs
Inner box	12*13*111cm(1pcs)
Master Carton	112*25*27cm(4pcs)



XP-293

Height	1350-2200mm
Load Capacity	75kgs
Inner box	14*14*140cm(1pcs)
Master Carton	30*30*142cm(6pcs)



XP-296

Height	1250-2200mm
Load Capacity	80kgs
Inner box	13.5*11.5*107.5cm(1pcs)
Master Carton	110*24*28cm(4pcs)



XP-269

Height	740-1340mm
Load Capacity	50kgs
Inner box	10*5.5*74cm(1pcs)
Master Carton	28*22*75cm(4pcs)



XP-283

Height	740-1340mm
Load Capacity	50kgs
Inner box	10*5.5*74cm(1pcs)
Master Carton	28*22*75cm(4pcs)



XP-285

Height	840-1280mm
Load Capacity	60kgs

(Note: XP-285 is marked as NEW)



XP-288A

Height	740-1340mm
Load Capacity	75kgs
Inner box	27*7*98cm(1pcs)
Master Carton	29*30*120cm(4pcs)



XP-288B

Height	740-1340mm
Load Capacity	75kgs
Inner box	27*7*98cm(1pcs)
Master Carton	29*30*120cm(4pcs)



XP-289A

Height	740-1340mm
Load Capacity	70kgs
Inner box	19*15.5*75cm(1pcs)
Master Carton	32*40*78cm(4pcs)



XP-289B

Height	740-1340mm
Load Capacity	70kgs
Inner box	19*15.5*75cm(1pcs)
Master Carton	32*40*78cm(4pcs)



XP-256

Inner box 65*11*75cm(1pcs)
Master Carton 68*25*78cm(2pcs)

XP-257

Inner box 47*11.5*3.8cm
Master Carton 52*26*27cm(10pcs)

XP-270

Inner box 65*11*75cm(1pcs)
Master Carton 68*25*78cm(2pcs)



XP-272

Inner box 17*11*63cm(1pcs)
Master Carton 37*35*65cm(6pcs)
Loading Capacity:50kgs



XP-273

Inner box 17*11*63cm(1pcs)
Master Carton 37*35*65cm(6pcs)
Loading Capacity:35kgs



XP-276

Inner box 25.5*9.5*43cm(1pcs)
Master Carton 54*27*45cm(5pcs)



XP-277

Inner box 25.5*5*43cm(1pcs)
Master Carton 52*27*45cm(10pcs)



XP-278

XP-279

XP-290



XP-294



XP-295



XM-505

Height 830-1150mm
Base 450mm
Inner box 44.2*5.6*61cm(1pcs)
Master Carton 46*26*65cm(5pcs)



XP-255M

colour:black/white
Height 1097-1847mm
Base material steel
Tube diameter Φ35mm Φ40mm m20
Base weight 10kg
Dimensions Base 490x490x15mm



XP-255L

colour:black/white
Height 1436-2436mm
Base material steel
Tube diameter Φ38mm Φ42mm m20
Base weight 13kg
Dimensions Base 550x550x15mm



XM-506

Height	915mm
Base	450mm
Inner box	46.5*4*90cm(1pcs)
Master Carton	48.5*19*92.5cm(4pcs)



XZ-718

Height	1750mm
Master Carton	36*11*106cm(4pcs)
Inner box	23*78*90cm
Master Carton	50*78*94cm(2pcs)



XZ-714



XZ-715



XZ-717

GUITAR STAND

ningbo xinxiang aud. electronical co.,ltd Produce And Design Your Stage!



XG-301

<i>Wood guitar stand</i>	
<i>Height</i>	<i>440mm</i>
<i>Inner box</i>	<i>35.5*8.5*45cm(1pc)</i>
<i>Master Carton</i>	<i>73*47*47cm(10pcs)</i>



XG-302

<i>Guitar stand(Electric/Wood dual application)</i>	
<i>Height</i>	<i>440mm</i>
<i>Inner box</i>	<i>35.5*8.5*45cm(1pc)</i>
<i>Master Carton</i>	<i>73*47*47cm(10pcs)</i>



XG-304

<i>Electric Guitar stand (Electric/Wood dual application)</i>	
<i>Height</i>	<i>440mm</i>
<i>Inner box</i>	<i>35.5*8.5*45cm(1pc)</i>
<i>Master Carton</i>	<i>73*47*47cm(10pcs)</i>



XG-305

<i>Wood guitar stand</i>	
<i>Height</i>	<i>440mm</i>
<i>Inner box</i>	<i>35.5*8*45cm(1pc)</i>
<i>Master Carton</i>	<i>73*47*47cm(10pcs)</i>

**XG-306**

Guitar stand(Electric/Wood dual application)
 Height 440mm
 Inner box 36.5*44.5cm(1pc)
 Master Carton 73*47*47cm(10pcs)

**XG-308**

Electric Guitar stand(Electric/Wood dual application)
 Height 685-910mm
 Color B/W
 Inner box 18*11*5.5cm(1pc)
 Master Carton 30*28*58cm(10pcs)

**XG-309**

Inner box 26*21*59.5cm(1pc)
 Master Carton 61*43*82cm(4pcs)

**XG-310**

Inner box 22*21*59.5cm(1pc)
 Master Carton 46*43*82cm(4pcs)

**XG-311**

Inner box 31.5*13*2.5cm(1pc)
 Master Carton 33*27*23cm(20pcs)

**XG-312**

Row stand for three guitars
 Width 540mm
 Height 790mm
 Inner box 46*12*60cm(1pc)
 Master Carton 47*26*82cm(2pcs)

**XG-313**

Row stand for five guitars
 Width 830mm
 Height 790mm
 Inner box 46*12*83cm(1pc)
 Master Carton 47*26*90cm(2pcs)

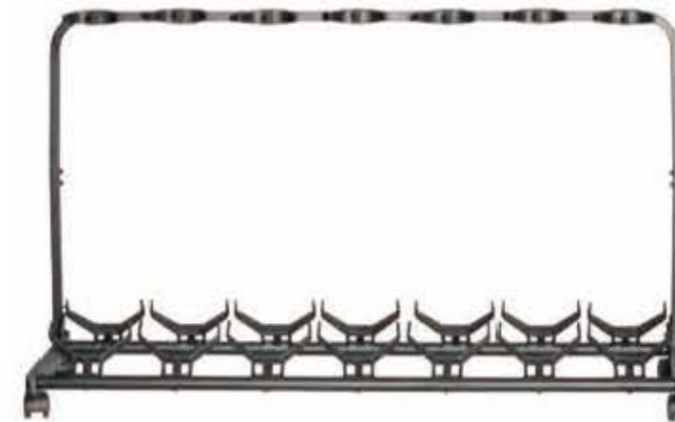
**XG-314**

Row stand for seven guitars
 Width 116mm
 Height 790mm
 Inner box 45*12*120cm(1pc)
 Master Carton 47*26*128cm(2pcs)

**XG-323**

Row stand for seven guitars(for five, for seven)
 Width 116mm
 Height 790mm
 Inner box 13*9*76.5cm(1pc)
 Master Carton 78*27.5*28.5cm(8pcs)



XG-322

Tripod guitar stand with auto locking hanger
 Innovative rapid height adjust mechanism: pull fastener by one hand to move up and down
 Two front tube covered by rubber for protection
 Height: 95-115cm
 Boom: 50-86cm
 Weight: 1.8kg
 Load capacity: 20kg
 Inner box: 10x10x75cm
 Carton: 54x22x79(10pcs)

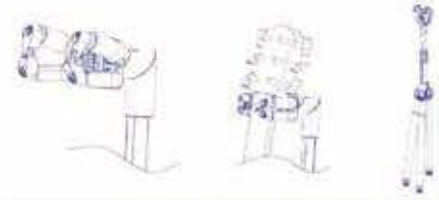

XG-328



XG-315 **XG-315L** **XG-316** **XG-316L**



XG-317 **XG-318** **XG-318L**



XG-329 **XG-330**



XG-319

Guitar stand(Electric/Wood dual application)
 Height 440mm
 Color R/Y/BL/BK/B/W
 Inner box 42*8*7cm(1pcs)
 Master Carton 46*41*37cm(20pcs)



KEYBOARD STAND

ningbo xinxiang aud. electronical co.,ltd Produce And Design Your Stage!

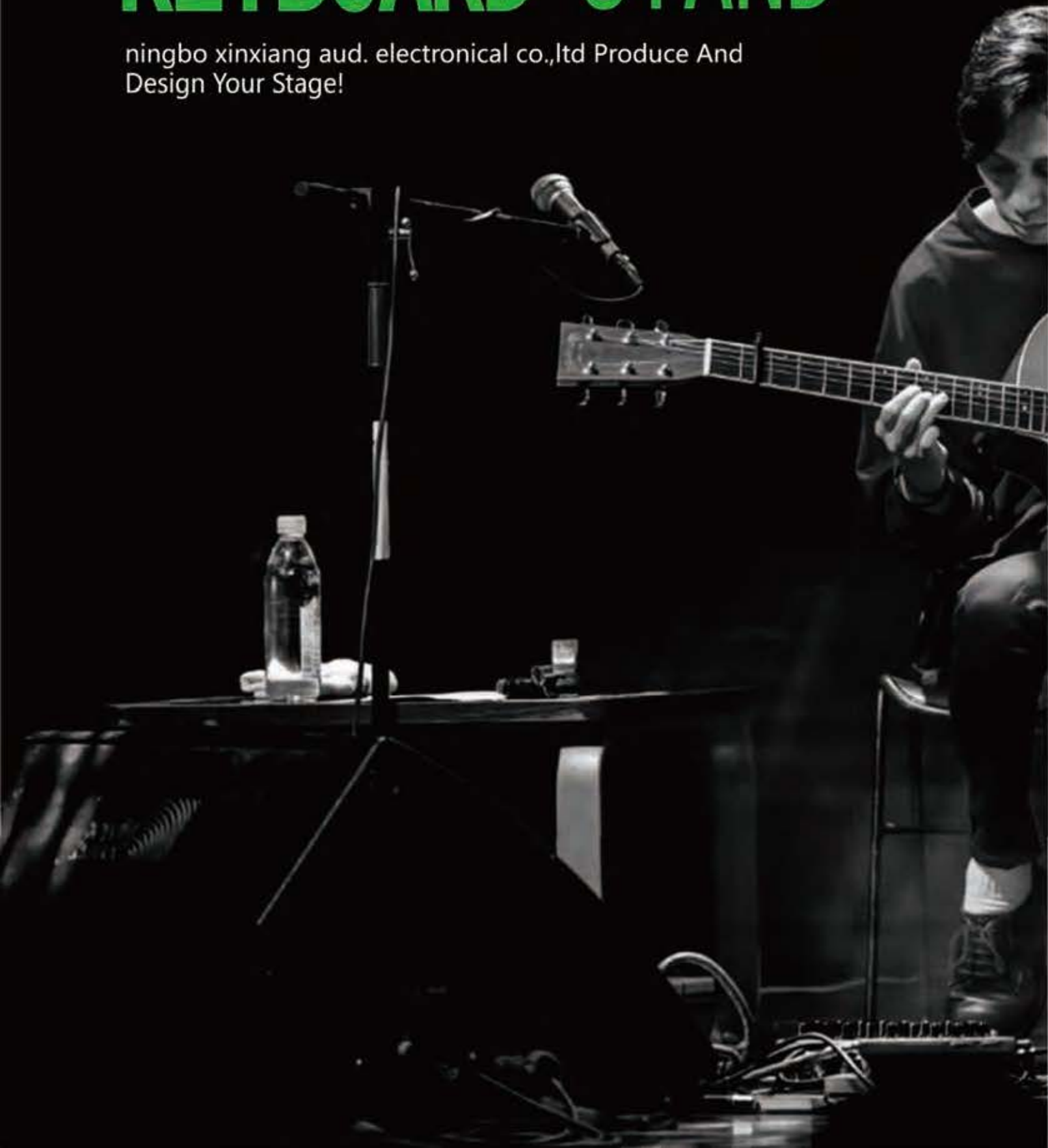

XX-361

Single X keyboard stand	
Height	560-970mm
Arm Length	Φ30*350mm
Inner box	51*8.5*103cm(1pcs)
Master Carton	52*45*105cm(5pcs)

XX-362

Single X keyboard stand	
Height	~920mm
Arm Length	Φ28*350mm
Inner box	97*12.5*7.5cm(1pcs)
Master Carton	101*27*28cm(6pcs)



XX-363

Double X keyboard stand	
Height	540-920mm
Arm Length	Φ28*350mm
Inner box	95.5*12.5*9cm(1pcs)
Master Carton	101*28*22cm(4pcs)

XX-364

Double X keyboard stand	
Height	560-970mm
Arm Length	Φ30*350mm
Inner box	51*8.5*103cm(1pcs)
Master Carton	52*29*105cm(3pcs)



XX-365

<i>Double keyboard stand</i>	
Height	560-970mm
Arm Length	Φ30*350mm
Inner box	51*8.5*103cm(1pcs)
Master Carton	52*29*105cm(3pcs)



XX-367

<i>Double X keyboard stand</i>	
Height	560-970mm
Arm Length	Φ30*410mm
Inner box	61*8.5*103cm(1pcs)
Master Carton	63*29*105cm(3pcs)



XX-398

<i>Double X keyboard stand</i>	
Height	560-970mm
Arm Length	Φ30*410mm
Inner box	61*8.5*103cm(1pcs)
Master Carton	63*29*105cm(3pcs)



XX-369

<i>Double keyboard stand with tier</i>	
Height	560-1310mm
Arm Length	Φ30*410mm
Inner box	60.5*10*108cm(1pcs)
Master Carton	64*33*112cm(3pcs)



XX-370

<i>Double keyboard stand with tier</i>	
Height	560-1310mm
Arm Length	Φ30*350mm
Inner box	51*11*101cm(1pcs)
Master Carton	55*36*103cm(3pcs)



XX-371

<i>Double keyboard stand with tier</i>	
Height	560-1310mm
Arm Length	Φ30*410mm
Inner box	67*12.5*109cm(1pcs)
Master Carton	69*40*112cm(3pcs)



XX-372

<i>Double keyboard stand with music stand and mic stand</i>	
Height	560-970mm
Arm Length	Φ28*350mm
Inner box	95.5*12.5*9cm(1pcs)
Master Carton	99*28*122cm(4pcs)



XX-373

<i>Heavy duty, double-brace keyboard stand with tier</i>	
Height	460-1580mm
Arm Length	Φ30*410mm
Inner box	66*12.5*104cm(1pcs)
Master Carton	68*28*107cm(2pcs)

XX-374

Inner box 17*12.5*48cm(1pcs)
 Master Carton 38*28*51cm(4pcs)



XX-375

Width 710mm
 Inner box 41*4.5*72cm(1pcs)
 Master Carton 43.5*21*74cm(4pcs)



XX-377

Height 670-850mm
 Arm Length 30*50*600mm
 Inner box 71.5*7*80.5cm(1pcs)
 Master Carton 73.5*18*85cm(2pcs)



XX-395

Height 558-850mm
 width 571-850mm
 Inner box 51.5*8*61cm(1pcs)
 Master Carton 54*18*64cm(2pcs)



XX-391-1B

Single keyboard stand
 Height 470-970mm
 Arm Length Φ28*410mm
 Inner box 97.5*12.5*12cm(1pcs)
 Master Carton 105*24*28cm(6pcs)



XX-391-2B

Double Keyboard stand
 Height 470-970mm
 Arm Length Φ28*410mm
 Inner box 97.5*12.5*12cm(1pcs)
 Master Carton 105*24*28cm(6pcs)



XX-394-1B

Single keyboard stand
 Height 470-970mm
 Arm Length Φ28*410mm
 Inner box 97.5*12.5*12cm(1pcs)
 Master Carton 105*24*28cm(6pcs)



XX-392

Double Keyboard stand
 Height 170-970mm
 Arm Length Φ28*410mm
 Inner box 97.5*12.5*12cm(1pcs)
 Master Carton 105*24*28cm(6pcs)



XX-378

Height 670-850mm
 Arm Length 30*50*600mm
 Inner box 78*11*60cm(1pcs)
 Master Carton 81*25*63cm(2pcs)



XX-379

Height 670-850mm
 Width 700-1040mm

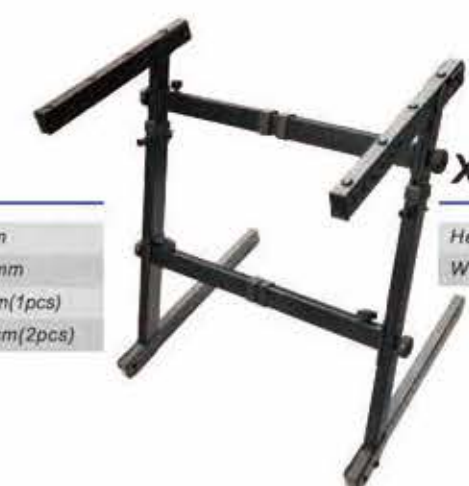

XAP-003



XAP-021



XAP-025



XAP-022



XX-388BL



XX-388BK



XX-388R



XX-388Y



XX-388W



XX-388

<i>Plane Keyboard stand</i>	
Height	1168mm
folded Length	1321mm
Load Capacity	up to 56Kgs per tier or 113Kgs total
color	R/Y/BL/BK/CH
Material	Aluminum
Inner box	22*22*136cm(1pcs)
Master Carton	142*25*48cm(2pcs)



XX-396

Height 570-810mm
width 810-1280mm



XX-396A

Height 570-810mm
width 810-1280mm

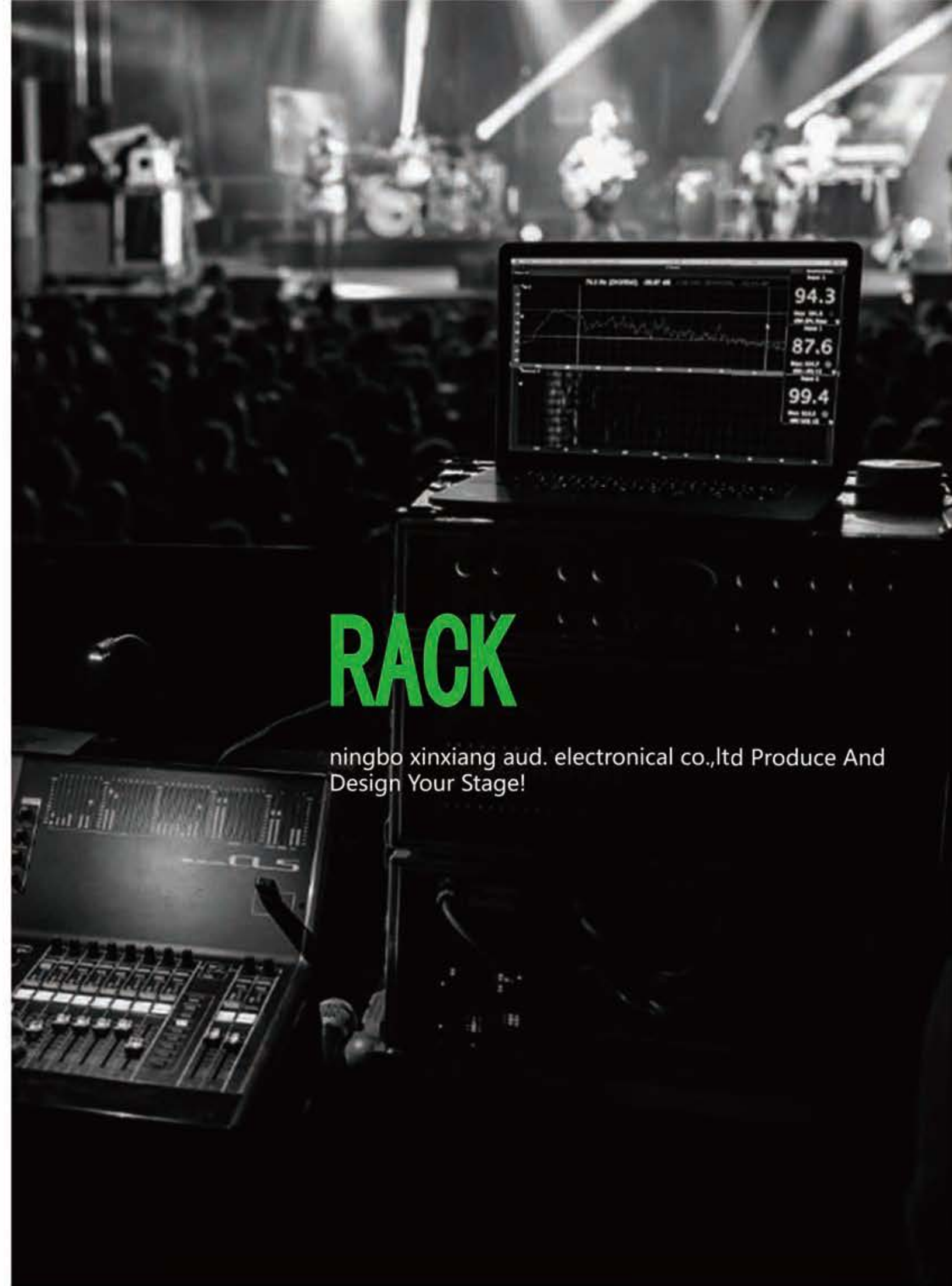

RACK

ningbo xinxiang aud. electronical co.,ltd Produce And Design Your Stage!

**XR-400**

Height	693mm
Depth	500mm
Width	540mm
Inner box	51.5*7.5*64cm(1pcs)
Master Carton	53*17*67cm(2pcs)

**XR-401****XR-402**

Height	693mm
Depth	500mm
Width	540mm
Inner box	50.5*3.5*64.5cm(1pcs)
Master Carton	54*15*68cm(1pcs)

**XR-403**

Depth	500mm
Width	540mm
Inner box	51*3.5*56cm(1pcs)
Master Carton	52.5*17.5*58.5cm(4pcs)

**XR-404****XR-405**

Height	625mm
Depth	500mm
Width	540mm
Inner box	76.5*13*56.5cm(1pcs)
Master Carton	78*27.7*59.5cm(2pcs)

**XR-406**

Depth	500mm
Width	540mm
Inner box	44*7.5*53cm(1pcs)
Master Carton	45.8*34*55.5cm(4pcs)

**XR-407**

Width	254mm
Inner box	26*12*57cm(1pcs)
Master Carton	66*56*60cm(10pcs)

**XR-408**

Width	495mm
Inner box	49.5*12*57cm(1pcs)
Master Carton	65*52*59cm(5pcs)

**XR-409**

Height	540mm
Width	475mm
Inner box	39.5*8.5*59.5cm(1pcs)
Master Carton	44*41.5*63.5cm(4pcs)

**XR-411**

Height	1540mm
base size	550mm
Inner box	55*8.5*134.5cm(1pcs)
Master Carton	58*20*138cm(2pcs)

**XR-412**

Height	915mm
base size	550mm
Inner box	76.5*13*59cm(1pcs)
Master Carton	79*29*62cm(2pcs)

**XR-412C**

Height	915mm
base size	550mm
Inner box	76.5*13*59cm(1pcs)
Master Carton	79*29*62cm(2pcs)



XR-413
2U(8.9cm)*483*355



XR-413-A
2U(8.9cm)*483*300



XR-413-B
2U(8.9cm)*483*455



XR-414
1U(4.45cm)*483*255



XR-414-A
1U(4.45cm)*483*300



XR-414-B
1U(4.45cm)*483*455



XR-414-C
1U(4.45cm)*483*255



XR-414-D
1U(4.45cm)*483*255



XR-415
1U*483*255



XR-416
1U*483*255



XR-417
1 UNIDADES (4.45CM)



XR-418
2 UNIDADES (8.9CM)



XR-419
3 UNIDADES (13.35CM)



XR-423
2 UNIDADES (8.9CM)



XR-427
4 UNIDADES (17.6CM)



XR-420
1 UNIDADES (4.45CM)



XR-424
1 UNIDADES (4.45CM)



XR-421
1 UNIDADES (4.45CM)



XR-425
2 UNIDADES (8.9CM)



XR-422
2 UNIDADES (8.9CM)



XR-426
3 UNIDADES (13.35CM)



XR-428
5 UNIDADES (22CM)



XR-435

Height	2 UNIDADES(89mm)
Width	400mm
Load Capacity	6.4kgs
Master Carton	49*9.5*42.5cm(1pcs)



XR-436

Height	3 UNIDADES(133mm)
Width	400mm
Load Capacity	7.4kgs
Master Carton	49*13.5*42.5cm(1pcs)



XR-437

Height	4 UNIDADES(176mm)
Width	400mm
Load Capacity	8.4kgs
Master Carton	49*18*42.5cm(1pcs)



XR-440

Height	1 UNIDADES(44.5mm)
Width	380-560mm



XR-438-8U
8 UNIDADES
458mm*505mm*519mm



XR-438-12U
12 UNIDADES
458mm*505mm*697mm



XR-438-16U
16 UNIDADES
458mm*505mm*875mm



XR-438-22U
22 UNIDADES
458mm*505mm*1142mm

**XB-454**

Height	520mm
Plate size	60*30cm
Inner box	31.5*16*60.5cm(1pcs)
Master Carton	69*33*64cm(4pcs)

**XB-455**

Height	520mm
Plate size	Φ30
Inner box	35*17*47cm(1pcs)
Master Carton	88*37*49cm(5pcs)

**XB-456**

Height	565-855mm,9positions
Load Capacity	112kgs
Inner box	40.5*16.5*99cm(1pcs)
Master Carton	43*37*103cm(2pcs)

**XB-457**

Height	455-635mm,7positins
Load Capacity	112kgs
Inner box	46*21*51cm(1pcs)
Master Carton	48*45*54cm(2pcs)

**XB-462****XB-461**

<i>Deluxe,nice piano bench</i>	
<i>Single,without book starag</i>	
<i>Seat size:55*33cm</i>	
<i>Height:46-56cm</i>	
<i>packing:1pcs/ctn</i>	
<i>Ctn size:68*34*13cm</i>	

**XB-458**

Height	482mm
Load Capacity	121kgs
Inner box	33*12*58.5cm(1pcs)
Master Carton	35*27*62cm(2pcs)

**XB-460**

<i>Economic piano&keyboard bench</i>	
<i>Seat size:74*35cm with book storage</i>	
<i>Height:50cm</i>	
<i>packing:1pcs/ctn</i>	
<i>Cth size:79*38.5*14.5</i>	

KEYBOARD STOOL

ningbo xinxiang aud. electronical co.,ltd Produce And
Design Your Stage!



XB-450

Height	430-530mm
Plate size	53*25cm
Inner box	31*10.5*58.5cm(1pcs)
Master Carton	47*33*62cm(4pcs)

XB-451

Height	480-580mm
Plate size	53*25cm
Inner box	31*12.5*58.5cm(1pcs)
Master Carton	53*33*62cm(4pcs)



XB-452

Height	470-605mm
Plate size	60*30cm
Inner box	36.5*14.5*72cm(1pcs)
Master Carton	77*35*65cm(4pcs)

XB-453

Height	435-570mm
Plate size	53*25cm
Inner box	430-605mm
Master Carton	69*39*74cm(4pcs)

**XM-503**

Height 680-1380mm
Master Carton 56*32*20cm(20pcs)

**XM-504**

Height 680-1380mm
Master Carton 56*32*20cm(20pcs)

**XM-507**

Height 920-1580mm
Inner box 36.5*9.5*85cm(1pcs)
Master Carton 54*39*84cm(5pcs)

**XM-509**

Compact tripod music stand
fast plate angle adjust
3 phase tube fast height adjust with quick locking design
plate:28x43cm
Height:95.5-135cm
Weight:1.7kg
Inner box:9.5x7.5x60cm
Carton:40x21x64cm(10pcs)

XM-510

Height 940-1420mm
Inner box 36*11*64cm(1pcs)
Master Carton 59*38*66cm(5pcs)



MUSIC STAND

ningbo xinxiang aud. electronical co.,ltd Produce And Design Your Stage!



XM-500

Height	940-1420mm
Inner box	36*11*61cm(1pcs)
Master Carton	59*38*63cm(5pcs)



XM-501

Height	940-1420mm
Inner box	36*11*61cm(1pcs)
Master Carton	59*38*63cm(5pcs)



XM-502

Height	910-1260mm
Inner box	36*11*91cm(1pcs)
Master Carton	59*38*93cm(5pcs)

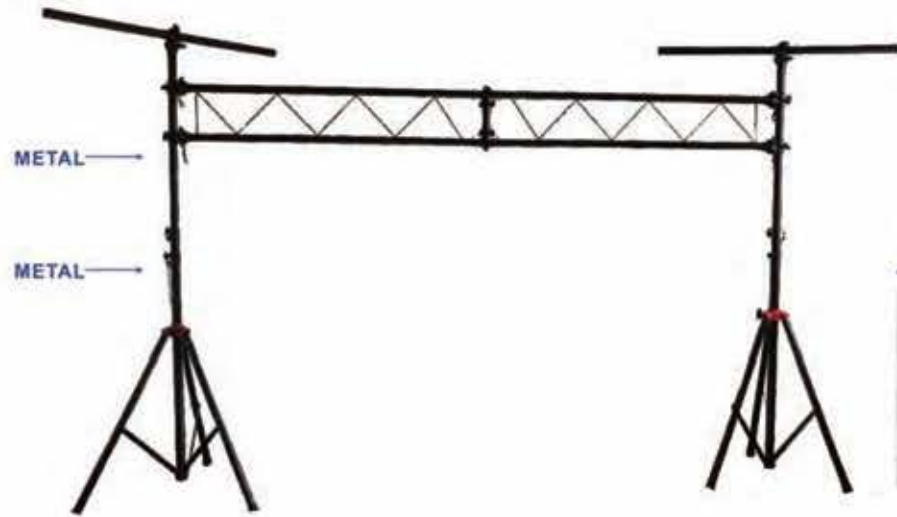

XL-557



Max Height	3500mm
Length	3000mm
Arm Length	1200mm
Load Capacity	150kgs
Master Carton	148*26*30cm(1pcs)



XL-558

Max Height	3000mm
Length	4000mm
Load Capacity	125kgs
Shipping Package	178*25*50cm(1set)
Shipping Package	20*20*20*200cm*2(1set)



- 2x  Model No. XL-567
- 2x  Model No. XW-617
- 2x  Steel 190mm

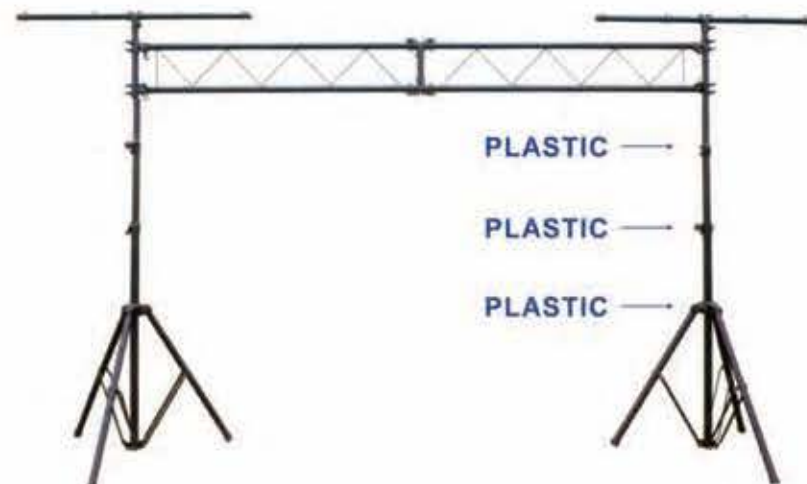

XL-559

Max Height	3500mm
Length	3000mm
Arm Length	1200mm
Load Capacity	120kgs
Master Carton	148*26*30cm(1pcs)

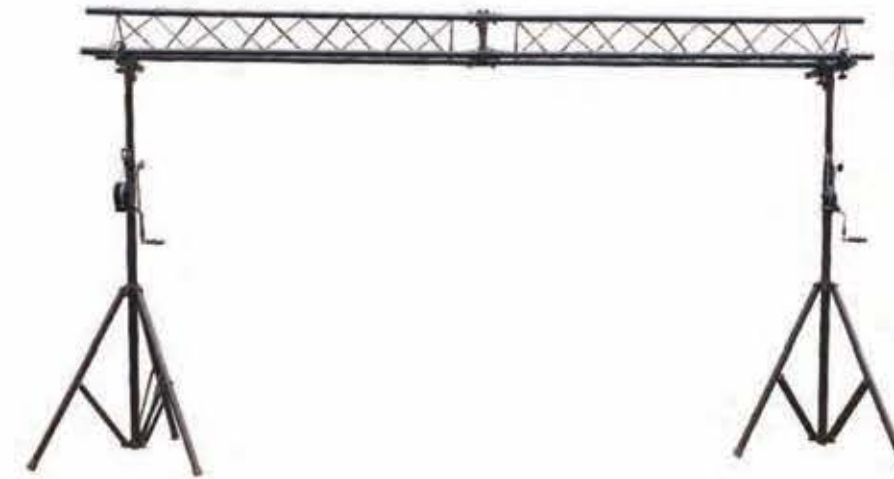

- 2x  Model No. XL-568
- 2x  Model No. XW-618
- 2x  Steel 290mm

XL-560

Max Height	3500mm
Length	4000mm
Load Capacity	150kgs
Shipping package	178*21*46cm(1set)
Shipping package	30*30*30*150cm*2(1set)



XL-561

Max Height	3000mm
Length	4000mm
Load Capacity	100kgs
Shipping package	190*18*33cm(1set)
Shipping package	20*20*20*200cm*2(1set)



- 2x  Model No. XL-565
- 2x  Model No. XW-617
- 2x  Steel 190mm

XL-562

Max Height	4500mm
Length	6000mm
Load Capacity	160kgs
Shipping package	168*21*55cm(1set)
Shipping package	30*30*30*300cm*2(1set)

- 2x  Model No. XL-566
- 2x  Model No. XW-618
- 2x  Aluminium 290mm

LIGHTING STAND

ningbo xinxiang aud. electronical co.,ltd Produce And Design Your Stage!

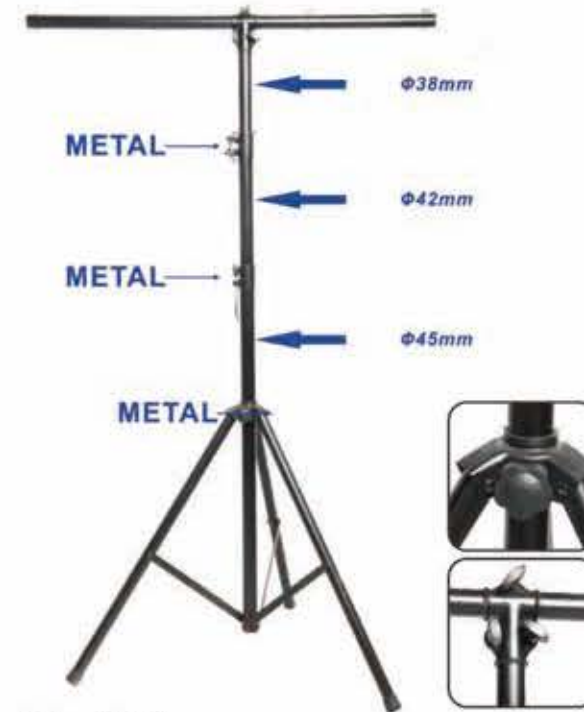

XL-550

Max Height	3500mm
Arm Length	1200mm
Load capacity	60kgs
Inner box	140*13.5*14.5cm(1pcs)
Master Carton	144*15*30cm(2pcs)

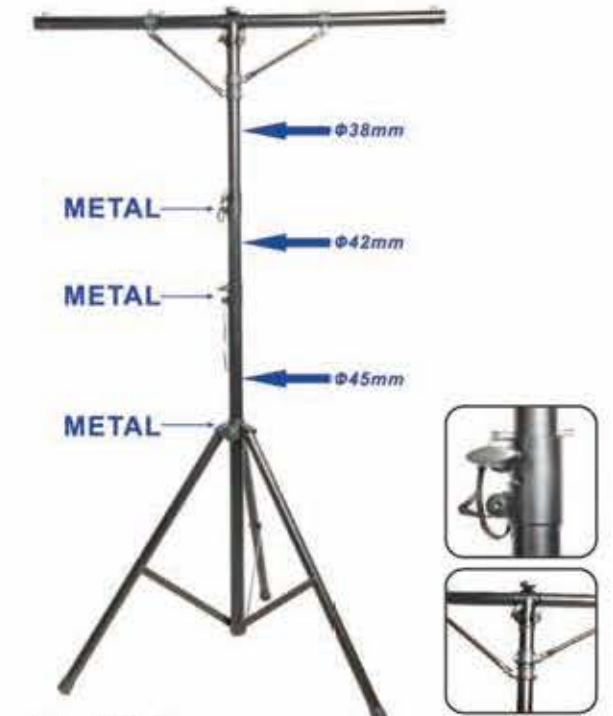

XL-551

Max Height	3500mm
Arm Length	1200mm
Load Capacity	60kgs
Inner box	140*13.5*14.5cm(1pcs)
Master Carton	144*15*30(2pcs)



XL-552

Max Height	3500mm
Arm Length	1200mm
Load Capacity	60kgs
Inner box	140*15*16cm(1pcs)
Master Carton	144*34*20cm(2pcs)



XL-553

Max Height	3000mm
Arm Length	1200mm
Load Capacity	60kgs
Inner box	140*13.5*14.5cm(1pcs)
Master Carton	144*15*30cm(2pcs)



XL-563

Max Height	4100mm
Load Capacity	80kgs
Inner box	165*19*25cm(1pcs)
Master Carton	168*21*55cm(2pcs)



XL-567

Max Height	3300mm
Load Capacity	70kgs
Inner box	187.5*18*19cm(1pcs)
Master Carton	178*25*50cm(1set)



XL-566

Max Height	4100mm
Load Capacity	80kgs
Inner box	165*19*25cm(1pcs)
Master Carton	168*21*55cm(2pcs)



XL-565

Max Height	2700mm
Load Capacity	60kgs
Inner box	187.5*18*15cm(1pcs)
Master Carton	190*18*33cm(2pcs)



XL-568

Max Height	3000mm
Load Capacity	70kgs
Inner box	172*18*19cm(1pcs)
Master Carton	178*25*50cm(1set)



XH-650

Min Height	1670mm
Max Height	3700mm
Diameter	1280mm
Load Capacity	50kgs
Inner box	182*21*25cm(1pcs)
Master Carton	185*45*29cm(2pcs)



XH-652

Min Height	1310mm
Max Height	3330mm
Diameter	1260mm
Load Capacity	40kgs
Inner box	140*21*25cm(1pcs)
Master Carton	144*45*29cm(2pcs)



XH-651

Min Height	1240mm
Max Height	3150mm
Diameter	1180mm
Load Capacity	40kgs
Inner box	135*21*25cm(1pcs)
Master Carton	138*45*29cm(2pcs)



XH-653

Min Height	1450mm
Max Height	2700mm
Diameter	1280mm
Load Capacity	50kgs
Inner box	175*21*25cm(1pcs)
Master Carton	178*45*29cm(2pcs)



XH-654

Min Height	1080mm
Max Height	1650mm
Diameter	1090mm
Load Capacity	50kgs
Inner box	125*21*19cm(1pcs)
Master Carton	128*27*35cm(2pcs)

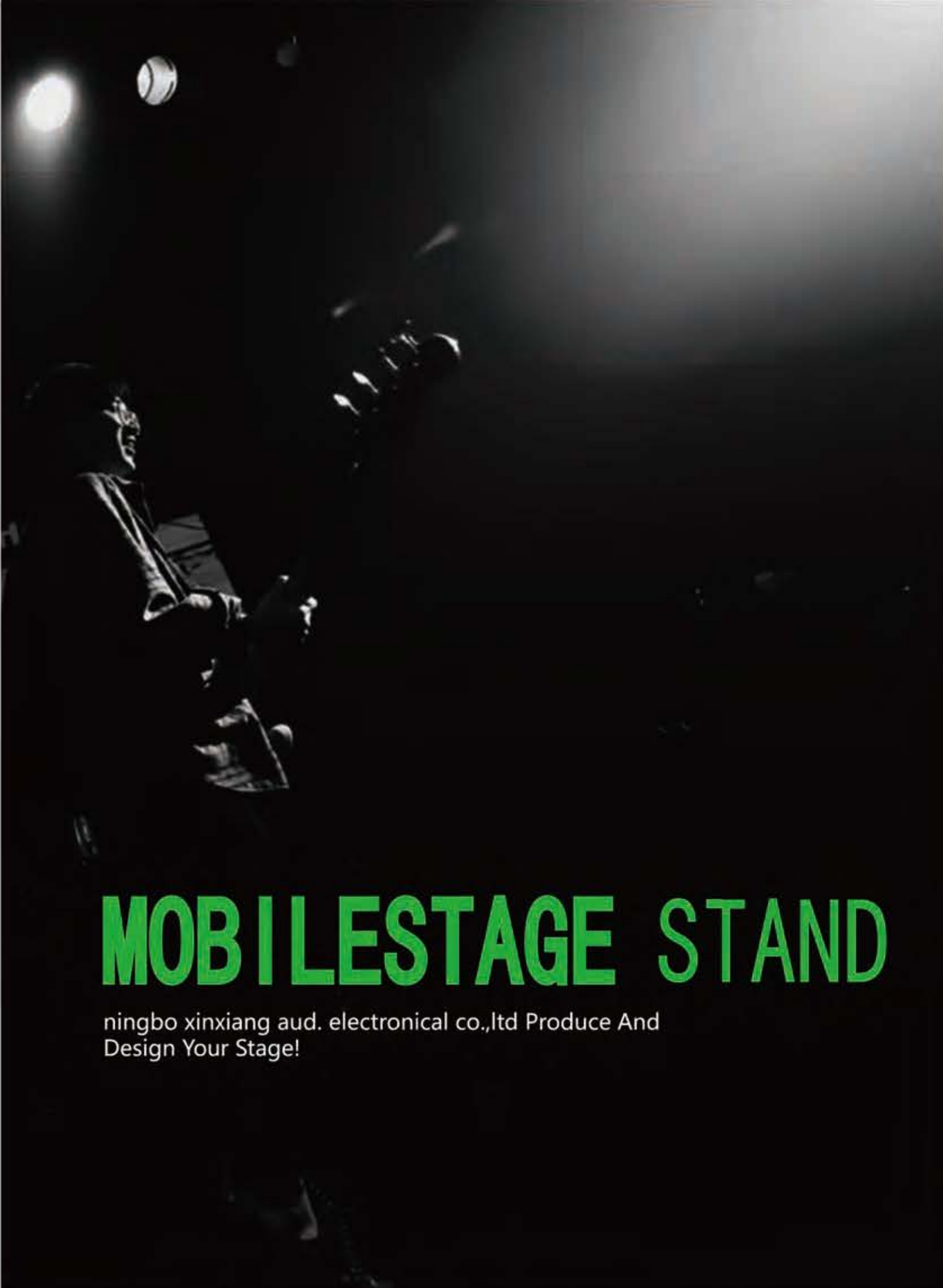

MOBILE STAGE STAND

ningbo xinxiang aud. electronical co.,ltd Produce And Design Your Stage!

**XL-580**

Load Capacity	220kg	
Min Height	1840mm	
Max Height	6500mm	
Base	2500mm	
Folded position	1930mm	
Shipping Package	193*47*47cm(1pcs)	

**XL-582**

Load Capacity	150kg	
Min Height	1890mm	
Max Height	5100mm	
Base	2100mm	
Folded position	2100mm	
Shipping Package	217*41*43cm(1pcs)	

**XL-581**

Load Capacity	120kg	
Min Height	1900mm	
Max Height	5100mm	
Base	2100mm	
Folded position	2000mm	
Shipping Package	203*42*42cm(1pcs)	

**XL-583**

Load Capacity	160kg	
Min Height	1750mm	
Max Height	5400mm	
Base	2100mm	
Folded position	1850mm	
Shipping Package	186*42*43cm(1pcs)	





XL-584

Load Capacity	220kg	
Min Height	1840mm	
Max Height	5400mm	
Base	2130mm	
Folded position	1900mm	
Shipping Package	190*46*63cm(1pcs)	



2x		Model No. XL-584
2x		Model No. XW-620
2x		Model No. XW-604 Aluminium 290mm

XL-590

Max Height	5400mm
Length	6000mm
Load Capacity	220kgs
Shipping Package	190*46.5*57.5cm(1set)
Shipping Package	30*30*30*300cm*2(1set)



2x		Model No. XL-582
2x		Model No. XW-618
2x		Model No. XW-604 Aluminium 290mm

XL-591

Max Height	5100mm
Length	6000mm
Load Capacity	150kgs
Shipping Package	186*41.6*45cm(1set)
Shipping Package	30*30*30*300cm*2(1set)



2x		Model No. XL-566
2x		Model No. XW-618
2x		Model No. Steel

XL-592

Max Height	4100mm
Length	3000mm
Load Capacity	160kgs
Shipping Package	168*30*55cm(1set)

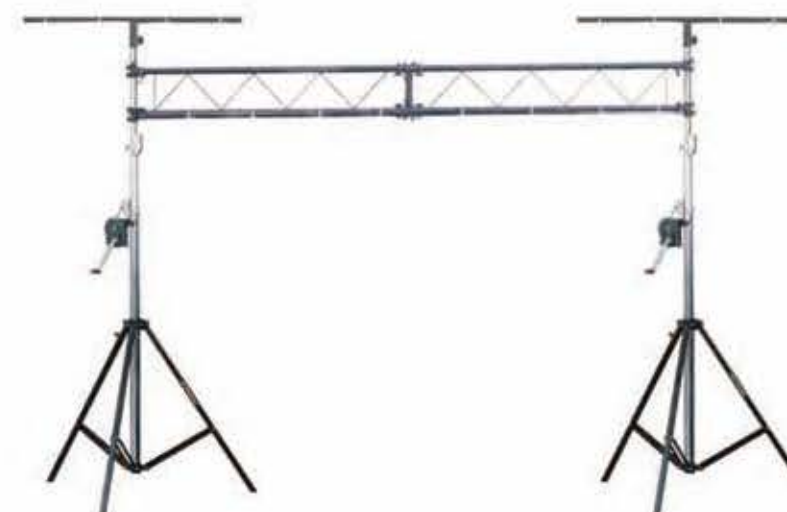

**XL-585BK/W**

Load Capacity	300kg	
Min Height	2050mm	
Max Height	6500mm	
Folded position	1900mm	
Shipping Package	210*72*91cm(1pcs)	

**XL-586BK/W**

Load Capacity	270kg	
Min Height	2050mm	
Max Height	8000mm	
Folded position	2000mm	
Shipping Package	210*72*91cm(1pcs)	

ALUMINIUM TRUSS

ningbo xinxiang aud. electronical co.,ltd Produce And Design Your Stage!

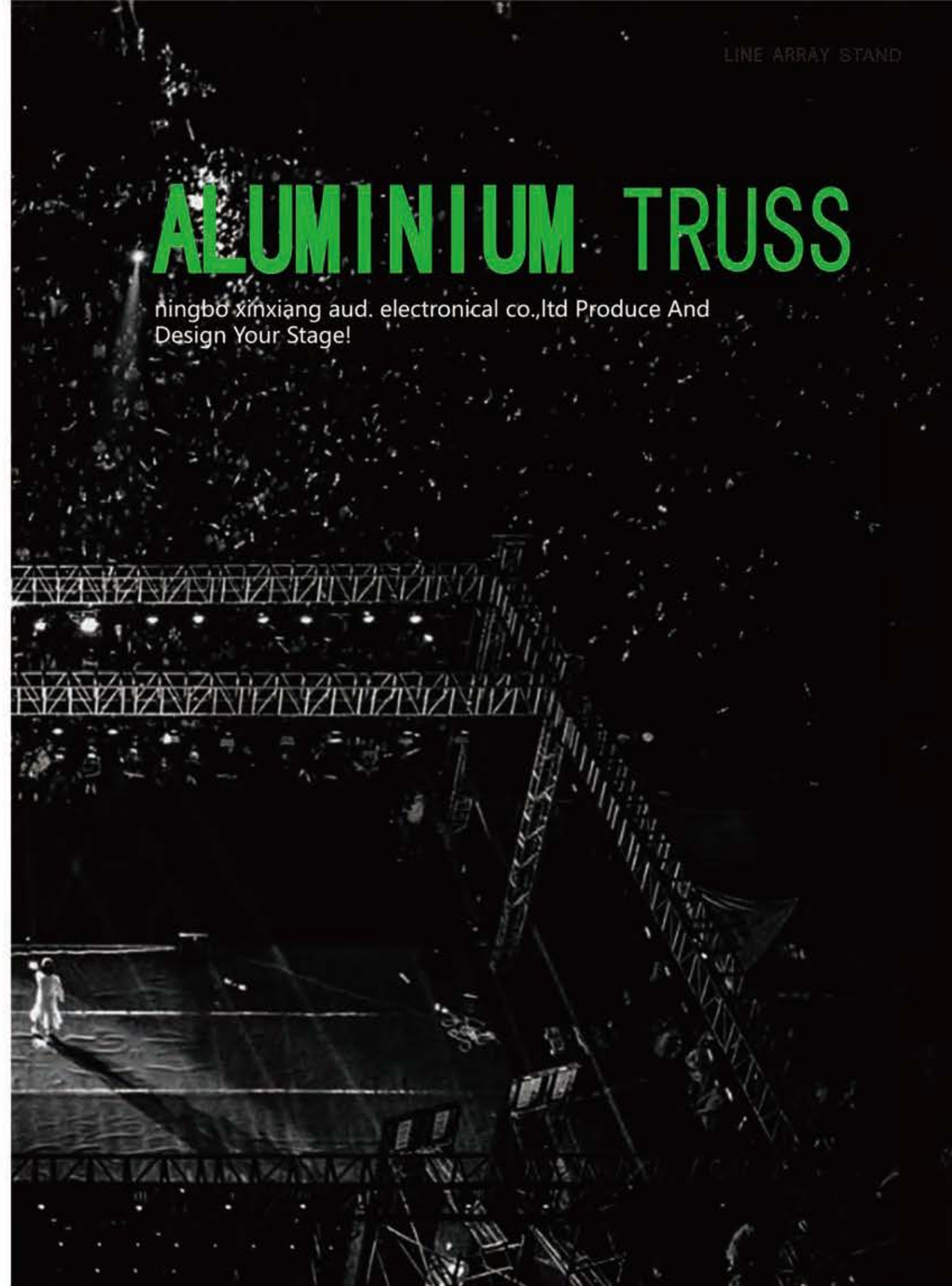



XW-662

Tube	50*3
Load Capacity	250kgs



XW-649

XW-665

XW-664



XW-663



XW-643
Size:660*660mm



XW-645
Size:495*495mm



XW-644
Size:330*644mm



XW-646
Size:300*300mm



Model

	8I	A	B	C	D	E	F	G	H	I	J
XW601	290	0.5	1.0	1.5	2.0	2.5	3.0	3.5	4.0	4.5	5.0
	8I	A	B	C	D	E	F	G	H	I	J
XW602	390	0.5	1.0	1.5	2.0	2.5	3.0	3.5	4.0	4.5	5.0



Model

XW603	250	A	B	C	D	E	F	G	H	I	J
XW604	250	A	B	C	D	E	F	G	H	I	J
XW605	350	A	B	C	D	E	F	G	H	I	J
XW606	390	A	B	C	D	E	F	G	H	I	J
XW607	450	A	B	C	D	E	F	G	H	I	J

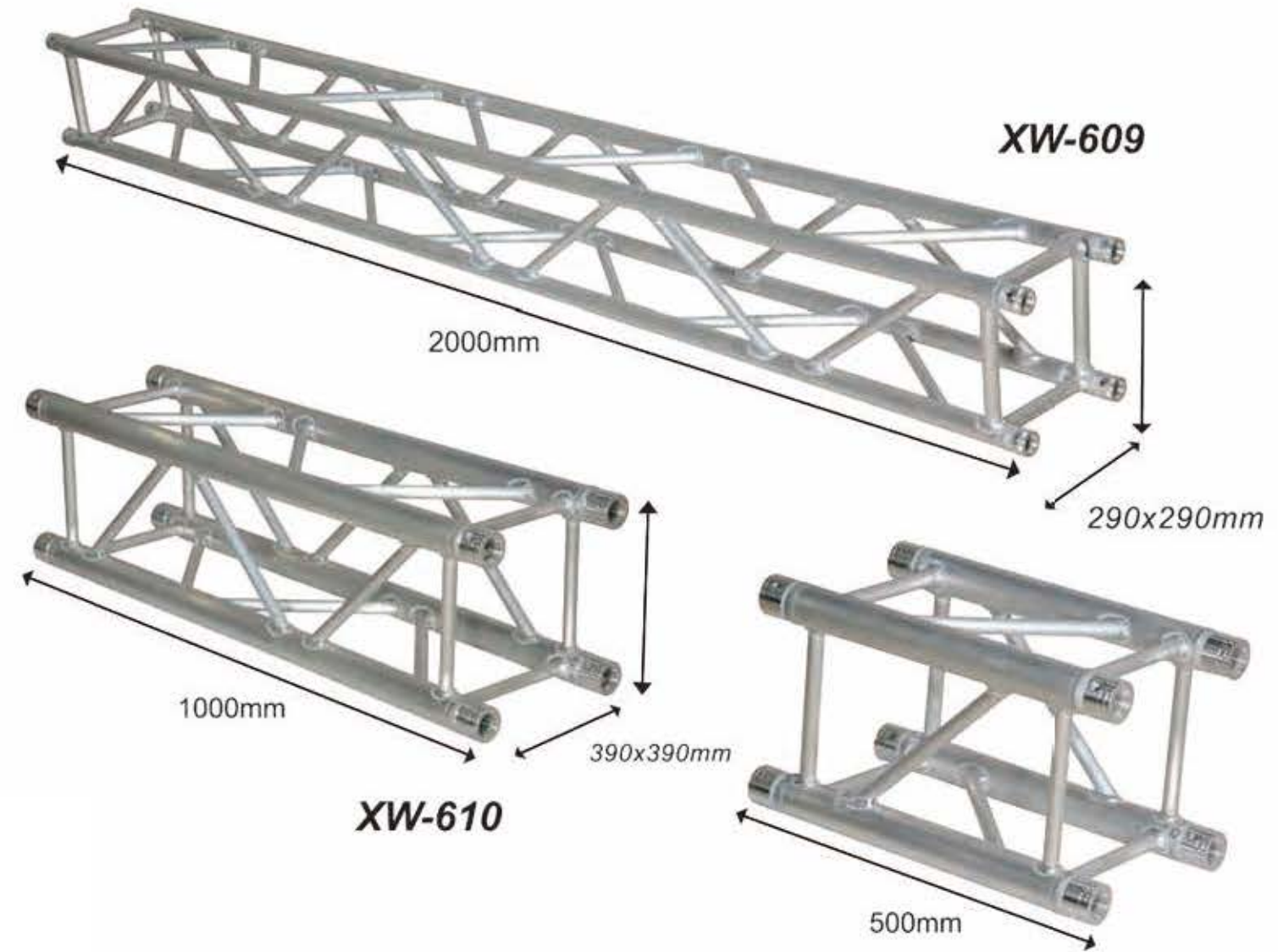

Model

XW608	220x220	A	B	C	D	E	F	G	H	I	J
XW609	290x290	A	B	C	D	E	F	G	H	I	J
XW610	390x390	A	B	C	D	E	F	G	H	I	J
XW611	290x400	A	B	C	D	E	F	G	H	I	J



XW-630



XW-630A



XW-630B



XW-633



XW-631



XW-631A



XW-632



XW-634



XW-635



XW-636



XW-637



XW-639



XW-647



XW-638



Model

	A	B	C	D	E	F	G	H	I	
XW608	290	Φ2m	Φ3m	Φ4m	Φ5m	Φ6m	Φ7m	Φ8m	Φ9m	Φ10m



XW-615

Suit For: ϕ 35mm



XW-680

Suit For: ϕ 38 or 50mm



XT-666

Suit For: ϕ 16-30mm



XT-668

Suit For: ϕ 30-50mm



XT-670

Suit For: ϕ 30-50mm



XT-674

Suit For: ϕ 30-50mm



XW-612

Suit For: ϕ 48-51mm



XW-613

Suit For: ϕ 35-38mm



XW-614

Suit For: ϕ 48-51mm



XW-640

Suit For: ϕ 48-50mm



XW-640-A

Suit For: ϕ 48-51mm



XW-641

Suit For: ϕ 48-50mm



XW-641-A

Suit For: ϕ 48-51mm



XW-641-B

Suit For: ϕ 48-51mm



XW-641-C

Suit For: ϕ 48-51mm



XW-642

Suit For: ϕ 48-51mm



XW-616-1M

Length: 1000mm



XW-616-07M

Length: 760mm



XW-617

Length: 150-200mm
Top of 35mm mast

XW-618

Length: 250-350mm
Top of 35mm mast

XW-619

Length: 200-500mm



XW-620

Length: 250-500mm
Top of 54mm mast

XW-621

Length: 200-400mm



XL-569

Top of a 35mm mast
T-bar $\Phi 50mm$
Length 1.5m
Master Carton 152*12*13.5cm(2pcs)

XL-570

Top of a 35mm mast
T-bar 30*30mm
Length 1.5m
Master Carton 155*25*13.5cm(5pcs)

XL-571

Top of a 35mm mast
T-bar 30*30mm
Length 2.0m
Master Carton 200*8.5*13.5cm(2pcs)

XZ-700

Mains Shelf Dimensions	
Height from floor	700mm
Width	1150mm
Depth	560mm
Top Shelf Dimensions	
Height from floor	900mm
Width	980mm
Depth	430mm
PuL-out Shelf Dimensions	
Height from floor	600mm
Width	790mm
Depth	350mm

Optional Color



XZ-702

Mains Shelf Dimensions	
Height from floor	700mm
Width	1150mm
Depth	560mm
Top Shelf Dimensions	
Height from floor	900mm
Width	1150mm
Depth	430mm
PuL-out Shelf Dimensions	
Height from floor	600mm
Width	790mm
Depth	350mm



XZ-703

Mains Shelf Dimensions	
Height from floor	720mm
Width	1750mm
Depth	610mm
Top Shelf Dimensions	
Height from floor	1000mm
Width	1960mm
Depth	380mm



XZ-704

Mains Shelf Dimensions	
Height from floor	710mm
Width	610mm
Depth	530mm
Top Shelf Dimensions	
Height from floor	760mm
Width	605mm





XC-904

Material	steel
length	900-1400mm
Height	300-1000mm
Dimensions:	folded 900*480*300
	Open 1400*480*1000



DJLAPTOP&MONITOR STAND

ningbo xinxiang aud. electrical co.,ltd Produce And Design Your Stage!





XZ-705

Four Height	235, 275, 315, 360mm
Three Width	290, 265, 240mm
Master Carton	32*31*34.5cm(5pcs)



XZ-706

Depth	185mm
Width	225-290mm
Four Height	235, 275, 315, 360mm
Three Width	290, 265, 240mm
Master Carton	32*31*34.5cm(5pcs)



XZ-709

Max Size	455*410*355mm(L*W*H)
Small Size	280*270*370mm(L*W*H)
Master Carton	49*30*45cm(5pcs)



XZ-710

Top Size	240*280mm
Three Height	360, 400, 440mm



XZ-707N

Height	260-360mm
Top Size	240*240mm
Load Capacity	15kgs
Master Carton	41*34*66.5cm(6pcs)



XZ-708

Height	350mm
Top Size	240*240mm
Load Capacity	15kgs
Master Carton	45*34.5*42.5cm(4pcs)



XZ-711

Height	700-1350mm
Plate Size	410*340mm



XZ-712

Height	700-1350mm
--------	------------



XZ-713



XZ-723



XPF-8001

Material	aluminum
Size	1300*1470*730mm
Color	W/BK
Inner box	137*76*15cm(1pcs)



XPF-8017

Material	steel
Width	2555mm
Height	1570-2700mm
Color	W/BK



XPF-8003

Material	aluminum
Dimensions	folded 1320*170*700mm set-up 1300*2000*730mm
Color	W/BK
Weight	22kg



XPF-8006

Material	steel
Size	1110*1050*520mm
Color	W/BK
Inner box	116*54*14cm(1pcs)
G.W	16kg



XPF-8031

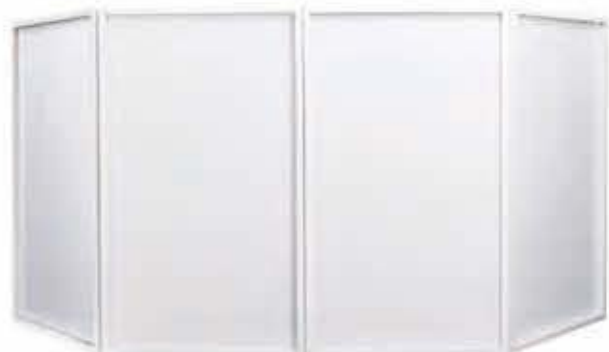

4 pcs white or black stretchable lycra with integrated velcro strips.

XPF-8015

Material	Steel
Size	1220*700(4pcs)



XF-150
1X MICROPHONE STAND BAG



XF-151
6X MICROPHONE STAND BAG



XF-152
1X LIGHT STAND BAG



XF-153
2X LIGHT STAND BAG



XF-154
1X SPEAKER STAND BAG



XF-155
2X SPEAKER STAND BAG



XF-156
1X MUSIC STAND BAG



XF-157



XF-158



XF-159



16" mirror ball

XZ-720A



20" mirror ball

XZ-720B



XDF-001

Material	aluminum
Dimensions	folded 600*600*100mm set-up 600*600*200mm
Color	W/BK



XDF-002

Material	aluminum
Dimensions	folded 600*600*100mm set-up 600*600*400mm
Color	W/BK



XDF-003

Material	aluminum
Dimensions	folded 600*600*100mm set-up 600*600*600mm
Color	W/BK



XDF-004

Material	aluminum
Dimensions	600*600*100mm 600*600*200mm
Color	W/BK

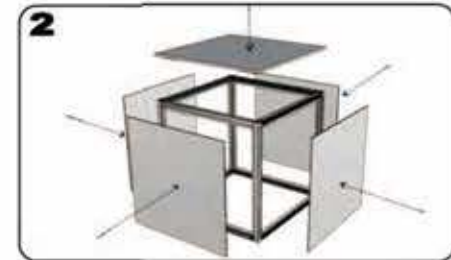

Made from strong aluminum framing and high-gloss white, black or clear acrylic. Because they're modular they set up quickly, and you can change your dance floor's size as needed.

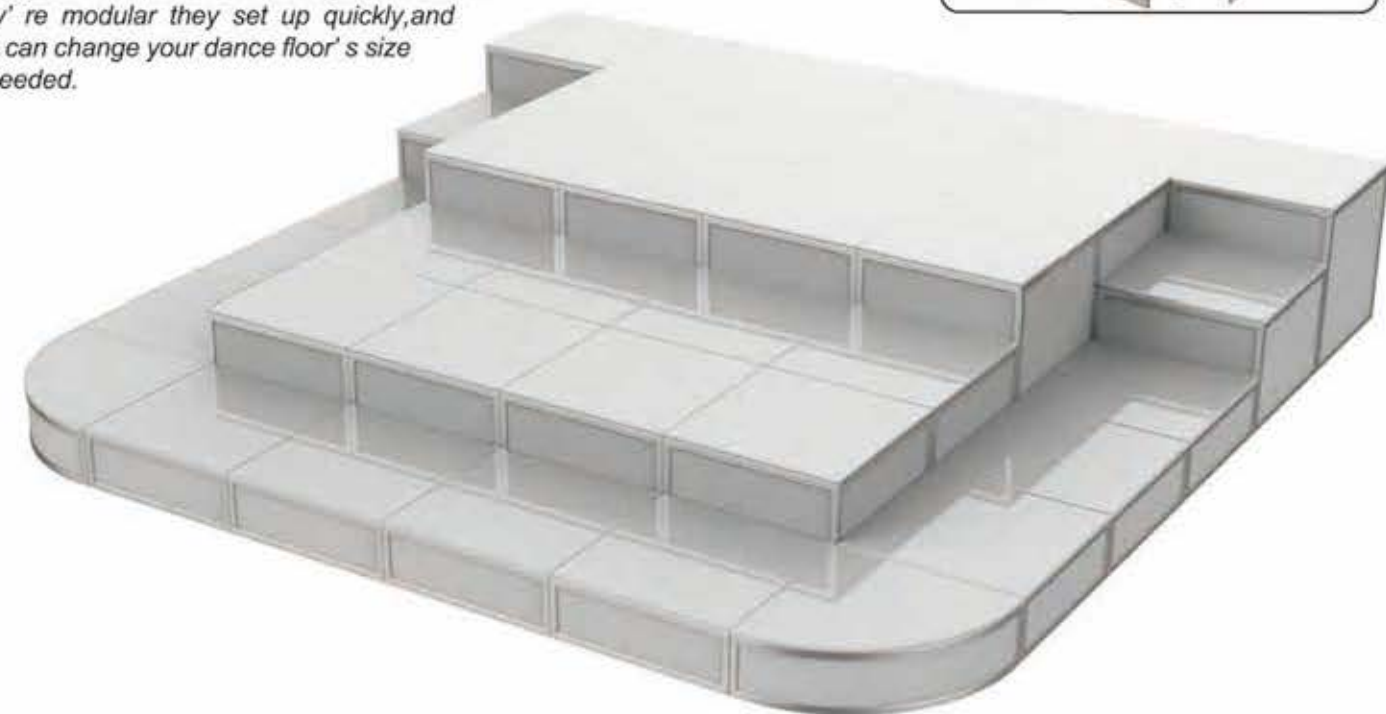



XE-804

XE-807



XE-806



性能 PERFORMANCE

PART NO型号	XTMC-A	DC Resis tance at 20C 直流电阻	Conductor 导体	≤88.9Ω/km
CONDUCTOR 导体	20/0.120FC		Shield 屏蔽	≤21.9Ω/km
IRE INFORMATION 线材资料	(20/0.120FC+PE)*2+Braid 128/0.100FC	Voltage Breakdown 耐电压	Must with stand at DC 125V/15s ec	
JACKET OD.外径	Φ6.5	Capacitance 电容	160pF/M	
SIZE 规格	0.23MM ² (24AWG)	Applicable Temperature 使用温度	-20℃~+70℃ (-4F~+158F)	



性能 PERFORMANCE

PART NO型号	XTMC-B	DC Resis tance at 20C 直流电阻	Conductor 导体	≤65.7 Ω/km
CONDUCTOR 导体	20/0.120FC		Shield 屏蔽	≤13.6 Ω/km
IRE INFORMATION 线材资料	(20/0.120FC+PE)*2+64/0.120FC	Voltage Breakdown 耐电压	Must with stand at DC 125V/15s ec	
JACKET OD.外径	Φ6.5	Capacitance 电容	98pF/M	
SIZE 规格	0.23MM ² (24AWG)	Applicable Temperature 使用温度	-20℃~+70℃ (-4F~+158F)	



XTMC001



XTMC002



XTMC003

-  21
-  22
-  23
-  24
-  25
-  26
-  27
-  28
-  29
-  30
-  31
-  32
-  33
-  34
-  35
-  36
-  37



XTM004



XTM005



XTM006



XTM007



XTM008



XTM009



XTM010



XTM011



XTM012



XTM013



XTM014



XTM015



性能 PERFORMANCE

PART NO型号	XTGC-A	DC Resis tance at 20C 直流电阻	Conductor 导体	≤63.6Ω/km
CONDUCTOR 导体	28/0.120FC		Shield 屏蔽	≤17.4Ω/km
WIRE INFORMATION 线材资料	28/0.120FC+PE+conductive PE +Braid 112/0.100FC	Voltage Breakdown 耐电压	Must with stand at DC 125V/15s ec	
JACKET OD.外径	Φ6.5	Capacitance 电容	61pF/M	
SIZE 规格	0.32MM ² (22AWG)	Applicable Temperature 使用温度	-20C~+70C (-4F~+158F)	



性能 PERFORMANCE

PART NO型号	XTGC-B	DC Resis tance at 20C 直流电阻	Conductor 导体	≤88.9Ω/km
CONDUCTOR 导体	20/0.120FC		Shield 屏蔽	≤55.6 Ω/km
WIRE INFORMATION 线材资料	(20/0.120FC)+PE+64/0.120FC Spiral	Voltage Breakdown 耐电压	Must with stand at DC 125V/15s ec	
JACKET OD.外径	Φ6.0	Capacitance 电容	83.8pF/M	
SIZE 规格	0.23MM ² (24AWG)	Applicable Temperature 使用温度	-20C~+70C (-4F~+158F)	

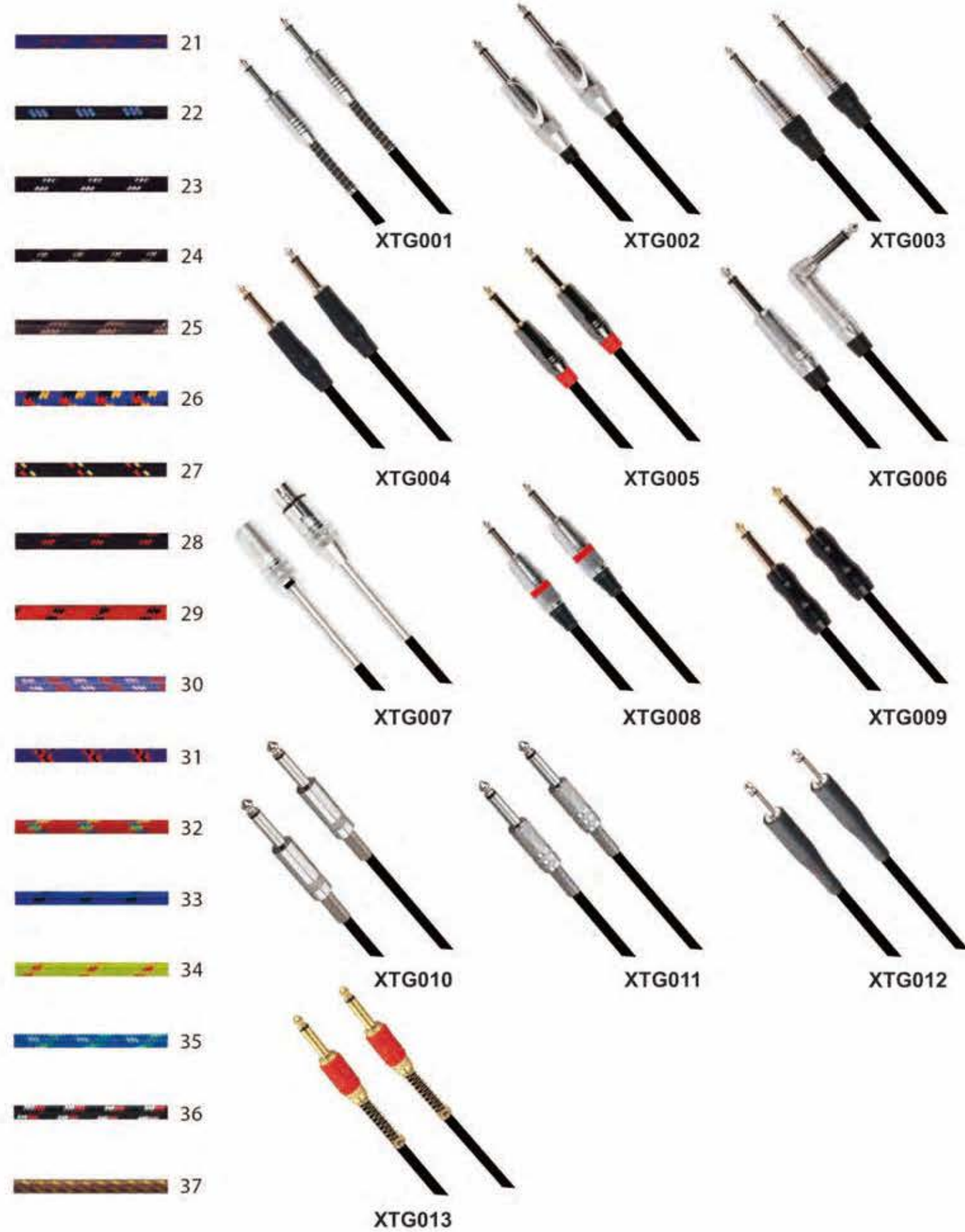

参数说明 PECIFICATION

PART NO 型号	GAUGE 导体规格 (AWG)	CONDUCTOR SIZE 导体规格 (mm ²)	JACKET OD.外径 (mm)	IMPEDANCE (≤) Ω/km阻抗
XTSC-A 001	11	2*4.0mm ²	Φ9.6	5
XTSC-A 002	12	2*3.30mm ²	Φ9.0	6
XTSC-A 003	13	2*2.5mm ²	Φ8.3	8
XTSC-A 004	14	2*2.0mm ²	Φ8.0	10
XTSC-A 005	15	2*1.5mm ²	Φ7.2	14
XTSC-A 006	16	2*1.31mm ²	Φ7.0	16
XTSC-A 007	17	2*1.0mm ²	Φ6.0	21
XTSC-A 008	18	2*0.83mm ²	Φ6.0	25
XTSC-A 009	20	2*0.52mm ²	Φ5.5	40



参数说明 PECIFICATION

PART NO 型号	GAUGE 导体规格 (AWG)	CONDUCTOR SIZE 导体规格 (mm ²)	JACKET OD.外径 (mm)	IMPEDANCE (≤) Ω/km阻抗
XTSC-B 001	13	2*2.5mm ²	Φ9.0	8
XTSC-B 002	14	2*2.0mm ²	Φ8.0	10
XTSC-B 003	15	2*1.5mm ²	Φ7.5	14
XTSC-B 004	16	2*1.30mm ²	Φ7.3	16
XTSC-B 005	17	2*1.0mm ²	Φ7.0	21
XTSC-B 006	18	2*0.75mm ²	Φ6.5	36
XTSC-B 007	20	2*0.5mm ²	Φ6.0	40



参数说明 PECIFICATION

PART NO 型号	GAUGE 导体规格 (AWG)	CONDUCTOR SIZE 导体规格 (mm ²)	JACKET OD.外径 (mm)	IMPEDANCE (≤) Ω/km阻抗
XTSC-C 001	11	4*4.0mm ²	Φ12.0	5
XTSC-C 002	12	4*3.30mm ²	Φ11.0	6
XTSC-C 003	13	4*2.5mm ²	Φ10.0	8
XTSC-C 004	14	4*2.0mm ²	Φ9.6	10
XTSC-C 005	15	4*1.5mm ²	Φ8.5	14
XTSC-C 006	16	4*1.31mm ²	Φ8.5	16
XTSC-C 007	17	4*1.0mm ²	Φ8.0	21
XTSC-C 008	18	4*0.75mm ²	Φ7.2	36
XTSC-C 009	20	4*0.5mm ²	Φ6.8	40



参数说明 PECIFICATION

PART NO 型号	GAUGE 导体规格 (AWG)	CONDUCTOR SIZE 导体规格 (mm ²)	JACKET OD.外径 (mm)	IMPEDANCE (≤) Ω/km阻抗
XTSC-D- 001	11	6*4.0mm ²	Φ16.0	5
XTSC-D 002	12	6*3.30mm ²	Φ14.0	6
XTSC-D 003	13	6*2.5mm ²	Φ13.5	8
XTSC-D 004	14	6*2.0mm ²	Φ13.0	10
XTSC-D 005	15	6*1.5mm ²	Φ11.0	14
XTSC-D 006	16	6*1.31mm ²	Φ10.5	16



XT5001

XT5002

XT5003

XT5005

XT5006



说明 SPECIFICATION

Voltage Breakdown 耐电压	Must with stand at DC 125V/15s ec
IMPEDANCE(≤)阻抗	214Ω/KM
Applicable Temperature 使用温度	-20C~ +70C (-4F~ +158F)
PART NO型号	XTLM-A
CONDUCTOR导体	20/0.120FC
CONDUCTOR SIZE导体规格 (mm ²)	16MM ² (25AWG)
DETAILS线材描述	{{(20/0.100FC + PE1.1)*2C + DW7/0.15TC + ALFOIL + PVC3.0}*CHANNEL + JACKET PVC

PART NO型号	CHANNEL 芯数	O.D(mm)外径
XTLM-A04	4	10
XTLM-A06	6	12
XTLM-A08	8	13
XTLM-A10	10	15
XTLM-A12	12	15.5
XTLM-A16	16	18
XTLM-A20	20	20
XTLM-A22	22	22
XTLM-A24	24	22
XTLM-A28	28	23.5
XTLM-A30	30	23.5
XTLM-A32	32	25
XTLM-A36	36	26
XTLM-A38	38	27
XTLM-A40	40	27
XTLM-A42	42	28
XTLM-A44	44	29
XTLM-A48	48	30
XTLM-A50	50	31
XTLM-A52	52	31
XTLM-A56	56	32



XTLM1-04	4 x JACK PLUG MONO TO 4 x JACK PLUG MONO	O.D. 10MM
XTLM1-06	6 x JACK PLUG MONO TO 6 x JACK PLUG MONO	O.D. 12MM
XTLM1-08	8 x JACK PLUG MONO TO 8 x JACK PLUG MONO	O.D. 13MM
XTLM1-12	12 x JACK PLUG MONO TO 12 x JACK PLUG MONO	O.D. 15.5MM



XTLM2-04	4 x JACK PLUG STEREO TO 4 x JACK PLUG STEREO	O.D. 10MM
XTLM2-06	6 x JACK PLUG STEREO TO 6 x JACK PLUG STEREO	O.D. 12MM
XTLM2-08	8 x JACK PLUG STEREO TO 8 x JACK PLUG STEREO	O.D. 13MM
XTLM2-12	12 x JACK PLUG STEREO TO 12 x JACK PLUG STEREO	O.D. 15.5MM



XTLM3-04	4 x JACK PLUG MONO TO 4 x RCA MALE	O.D. 10MM
XTLM3-06	6 x JACK PLUG MONO TO 6 x RCA MALE	O.D. 12MM
XTLM3-08	8 x JACK PLUG MONO TO 8 x RCA MALE	O.D. 13MM
XTLM3-12	12 x JACK PLUG MONO TO 12 x RCA MALE	O.D. 15.5MM



XTLM4-04	4 x RCA MALE TO 4 x RCA MALE	O.D. 10MM
XTLM4-06	6 x RCA MALE TO 6 x RCA MALE	O.D. 12MM
XTLM4-08	8 x RCA MALE TO 8 x RCA MALE	O.D. 13MM
XTLM4-12	12 x RCA MALE TO 12 x RCA MALE	O.D. 15.5MM

XTLM5-04	4 x XLR FEMALE TO 4 x JACK PLUG STEREO	O.D. 10MM
XTLM5-06	6 x XLR FEMALE TO 6 x JACK PLUG STEREO	O.D. 12MM
XTLM5-08	8 x XLR FEMALE TO 8 x JACK PLUG STEREO	O.D. 13MM
XTLM5-12	12 x XLR FEMALE TO 12 x JACK PLUG STEREO	O.D. 15.5MM



XTLM6-04	4 x JACK PLUG STEREO TO 4 x XLR MALE PLUG	O.D. 10MM
XTLM6-06	6 x JACK PLUG STEREO TO 6 x XLR MALE PLUG	O.D. 12MM
XTLM6-08	8 x JACK PLUG STEREO TO 8 x XLR MALE PLUG	O.D. 13MM
XTLM6-12	12 x JACK PLUG STEREO TO 12 x XLR MALE PLUG	O.D. 15.5MM



XTLM7-04	4 x JACK PLUG STEREO TO 4 x JACK PLUG STEREO	O.D. 10MM
XTLM7-06	6 x JACK PLUG STEREO TO 6 x JACK PLUG STEREO	O.D. 12MM
XTLM7-08	8 x JACK PLUG STEREO TO 8 x JACK PLUG STEREO	O.D. 13MM
XTLM7-12	12 x JACK PLUG STEREO TO 12 x JACK PLUG STEREO	O.D. 15.5MM



XTLM8-04	4 x XLR FEMALE TO 4 x XLR MALE	O.D. 10MM
XTLM8-06	6 x XLR FEMALE TO 6 x XLR MALE	O.D. 12MM
XTLM8-08	8 x XLR FEMALE TO 8 x XLR MALE	O.D. 13MM
XTLM8-12	12 x XLR FEMALE TO 12 x XLR MALE	O.D. 15.5MM





XTLM9-04 4 x DB25 PLUG TO 4 x XLR MALE PLUG O.D. 10MM

XTLM9-06 6 x DB25 PLUG TO 6 x XLR MALE PLUG O.D. 12MM

XTLM9-08 8 x DB25 PLUG TO 8 x XLR MALE PLUG O.D. 13MM

XTLM9-12 12x DB25 PLUG TO 12 x XLR MALE PLUG O.D. 15,5MM



XTLM10-04 DB25 PLUG TO 4 x XLR FEMALE O.D. 10MM

XTLM10-06 DB25 PLUG TO 6x XLR FEMALE O.D. 12MM

XTLM10-08 DB25 PLUG TO 8 x XLR FEMALE O.D. 13MM

XTLM10-12 DB25 PLUG TO 12 x XLR FEMALE O.D. 15.5MM



XTLM11-04 DB25 PLUG TO 4 x JACK PLUG STEREO O.D. 10MM

XTLM11-06 DB25 PLUG TO 6 x JACK PLUG STEREO O.D. 10MM

XTLM11-08 DB25 PLUG TO 8 x JACK PLUG STEREO O.D. 10MM

XTLM11-12 DB25 PLUG TO 12 x JACK PLUG STEREO O.D. 10MM



XTLM12-08 8CH (4 + 4) 4 xlr male + 4 xlr female to 4 xlr female + 4 xlr male

XTLM12-12 12CH (8 + 4) 8 xlr male + 4 xlr female to 4 xlr female + 4 xlr male

XTLM12-16 16CH (12 + 4) 12 xlr male + 4 xlr female to 12 xlr female + 4 xlr male

XTLM12-20 20CH (16 + 4) 16 xlr male + 4 xlr female to 16 xlr female + 4 xlr male

XTLM12-24 24CH (20 + 4) 20 xlr male + 4 xlr female to 20 xlr female + 4 xlr male

XTLM12-28 28CH (24 + 4) 24 xlr male + 4 xlr female to 24 xlr female + 4 xlr male

XTLM12-32 32CH (28 + 4) 28 xlr male + 4 xlr female to 28 xlr female + 4 xlr male

XTLM12-36 36CH (32 + 4) 32 xlr male + 4 xlr female to 32 xlr female + 4 xlr male

XTLM12-40 40CH (36 + 4) 36 xlr male + 4 xlr female to 36 xlr female + 4 xlr male

XTLM13-08 8CH (4 + 4) 4 xlr male + 4 xlr female to 4 xlr female + 4 xlr male

XTLM13-12 12CH (8 + 4) 8 xlr male + 4 xlr female to 4 xlr female + 4 xlr male

XTLM13-16 16CH (12 + 4) 12 xlr male + 4 xlr female to 12 xlr female + 4 xlr male

XTLM13-20 20CH (16 + 4) 16 xlr male + 4 xlr female to 16 xlr female + 4 xlr male

XTLM13-24 24CH (20 + 4) 20 xlr male + 4 xlr female to 20 xlr female + 4 xlr male

XTLM13-28 28CH (24 + 4) 24 xlr male + 4 xlr female to 24 xlr female + 4 xlr male

XTLM13-32 32CH (28 + 4) 28 xlr male + 4 xlr female to 28 xlr female + 4 xlr male



XTLM14-08 8CH (4 + 4) 4 xlr male + 4 xlr female to 4 xlr female + 4 xlr male

XTLM14-12 12CH (8 + 4) 8 xlr male + 4 xlr female to 4 xlr female + 4 xlr male

XTLM14-16 16CH (12 + 4) 12 xlr male + 4 xlr female to 12 xlr female + 4 xlr male

XTLM14-20 20CH (16 + 4) 16 xlr male + 4 xlr female to 16 xlr female + 4 xlr male

XTLM14-24 24CH (20 + 4) 20 xlr male + 4 xlr female to 20 xlr female + 4 xlr male

XTLM14-28 28CH (24 + 4) 24 xlr male + 4 xlr female to 24 xlr female + 4 xlr male

XTLM14-32 32CH (28 + 4) 28 xlr male + 4 xlr female to 28 xlr female + 4 xlr male

XTLM14-36 36CH (32 + 4) 32 xlr male + 4 xlr female to 32 xlr female + 4 xlr male

XTLM14-40 40CH (36 + 4) 36 xlr male + 4 xlr female to 36 xlr female + 4 xlr male



XTLM15-08 8CH (4 + 4) 4 xlr male + 4 xlr female to 4 xlr female + 4 xlr male

XTLM15-12 12CH (8 + 4) 8 xlr male + 4 xlr female to 4 xlr female + 4 xlr male

XTLM15-16 16CH (12 + 4) 12 xlr male + 4 xlr female to 12 xlr female + 4 xlr male

XTLM15-20 20CH (16 + 4) 16 xlr male + 4 xlr female to 16 xlr female + 4 xlr male

XTLM15-24 24CH (20 + 4) 20 xlr male + 4 xlr female to 20 xlr female + 4 xlr male

XTLM15-28 28CH (24 + 4) 24 xlr male + 4 xlr female to 24 xlr female + 4 xlr male

XTLM15-32 32CH (28 + 4) 28 xlr male + 4 xlr female to 28 xlr female + 4 xlr male

XTLM15-36 36CH (32 + 4) 32 xlr male + 4 xlr female to 32 xlr female + 4 xlr male

XTLM15-40 40CH (36 + 4) 36 xlr male + 4 xlr female to 36 xlr female + 4 xlr male





XTLM16-08	8CH (4 + 4)	4 xlr male + 4 xlr female to 4 xlr female + 4 xlr male
XTLM16-12	12CH (8 + 4)	8 xlr male + 4 xlr female to 4 xlr female + 4 xlr male
XTLM16-16	16CH (12 + 4)	12 xlr male + 4 xlr female to 12 xlr female + 4 xlr male
XTLM16-20	20CH (16 + 4)	16 xlr male + 4 xlr female to 16 xlr female + 4 xlr male
XTLM16-24	24CH (20 + 4)	20 xlr male + 4 xlr female to 20 xlr female + 4 xlr male
XTLM16-28	28CH (24 + 4)	24 xlr male + 4 xlr female to 24 xlr female + 4 xlr male
XTLM16-32	32CH (28 + 4)	28 xlr male + 4 xlr female to 28 xlr female + 4 xlr male
XTLM16-36	36CH (32 + 4)	32 xlr male + 4 xlr female to 32 xlr female + 4 xlr male
XTLM16-40	40CH (36 + 4)	36 xlr male + 4 xlr female to 36 xlr female + 4 xlr male

CABLE GLAND



规格	Dimma0.1	Binnia0.1	Dimma0.1	Lineja0.1	L11Amm0.1	L2mm0.1
PG7	12.4	17.8	19.5	30.3	8	4.8
PG9	15.2	21.9	23.7	39.6	9	4.6
PG11	18.2	25.75	26.1	51.4	8	5
PG13.5	20	28.8	29.4	36.4	9	5
PG16	22.2	28.8	31.9	37.5	10	5.2
PG19	23.9	28.9	31.9	48	10	5.3
PG21	26.2	35.7	38.9	44.9	10	5.9
PG25	29.9	35.9	39.9	44.6	11	7
PG29	36.5	46	50.5	50.7	13	7
PG36	48.7	58.7	64	58.4	13.7	7.4
PG42	53.6	63.5	69.8	67.9	14	7.4
PG48	58.5	70.3	77.8	62.8	15.6	7.4
PG63	71.6	82.3	91.5	84.5	28.5	8.8

AUDIO CABLE



XTY001

XTY002

XTY003

XTY004



XGRJ45-H-1



XGRJ45-H-3



XGRJ45-H-5



XGRJ45-H-2



XGRJ45-H-4



XGRJ45-H-6



XGRJ45-K-1



XGRJ45-K-2



XGRJ45-K-3



XGRJ45-K-4



XGRJ45-K-5



XGRJ45-M-2



XGRJ45-M-6



XGRJ45-005



XGRJ45-006

接点电阻	< 10 mΩ
绝缘强度	1 kVdc
带宽频率	1 - 100 MHz
绝缘电阻	> 0.5 GΩ
接点额定电流	1.5 A
额定电压	50 V
线径	6-7 mm
插拔力	< 50 N
寿命	> 1000 次

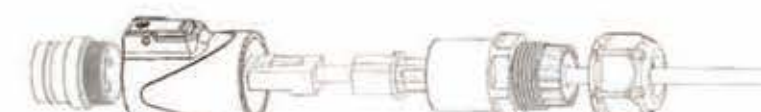



XGYS-011WP



XGYS-012WP



XGYS-013WP



XGYS-014WP



XGYS-010



XGYS-020



XGYS-009



XGYS-020



XGYS-010WP



XGYS-009WP

XGYS-019WP_{RL}

XGYS-019WP



XGYS-001A



XGYS-001B



XGYS-002A



XGYS-002B

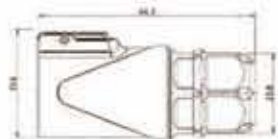

额定电流 25 A
 额定电压 500V Ac
 接触电阻 $\leq 5 m\Omega$
 绝缘强度 2000V
 绝缘电阻 2000M Ω
 触点数 2+PE
 使用寿命 1000次循环
 端子操作方式 螺丝固定
 线径范围 8mm-17mm
 连接导体 Flexible 软线



XG-01



XG-02



XG-03



XG-04



XG-05



XG-06



XG-07



XGYX-001CH



XGYX-001BK



XGYX-003CH



XGYX-002CH



XGYX-002BK



XGYX-004CH



XGYR-001CH



XGYR-002BK



XGYJ-003CH



XGYJ-004BK



XGYJ-001CH



XGYJ-001BK



XGYJ-002CH



XGYJ-002BK